

Cours N°4

Ombres et lumières

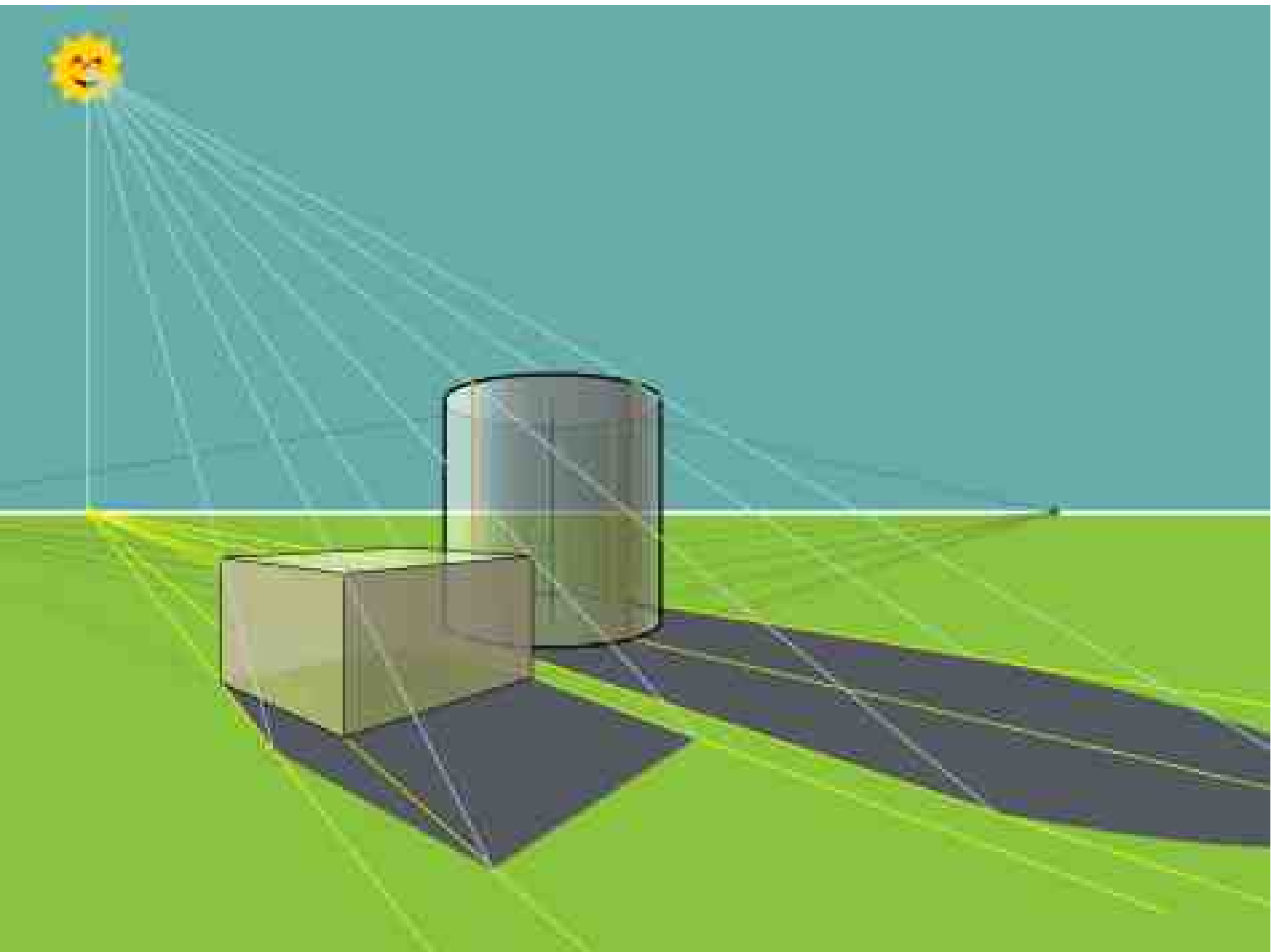

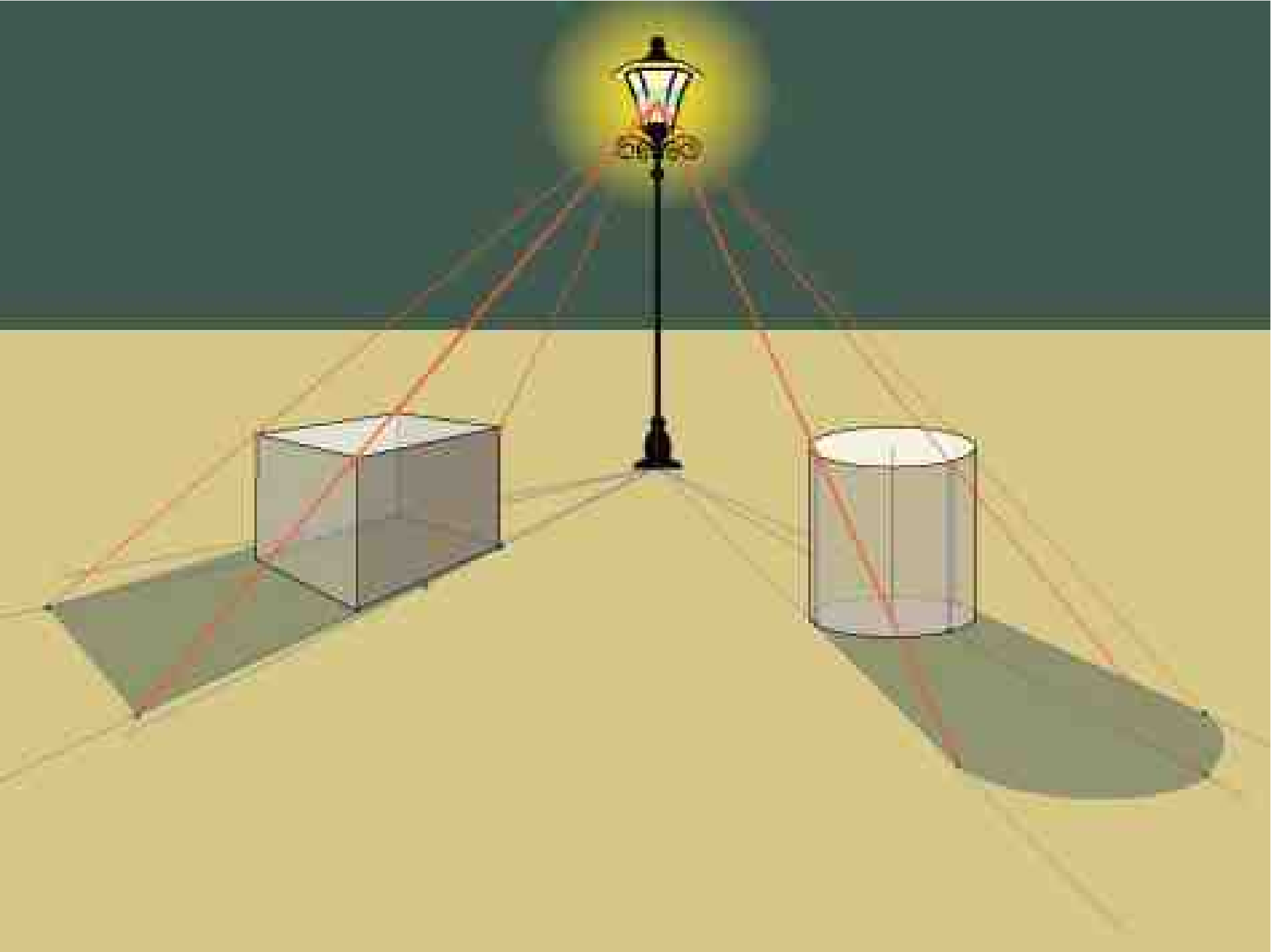



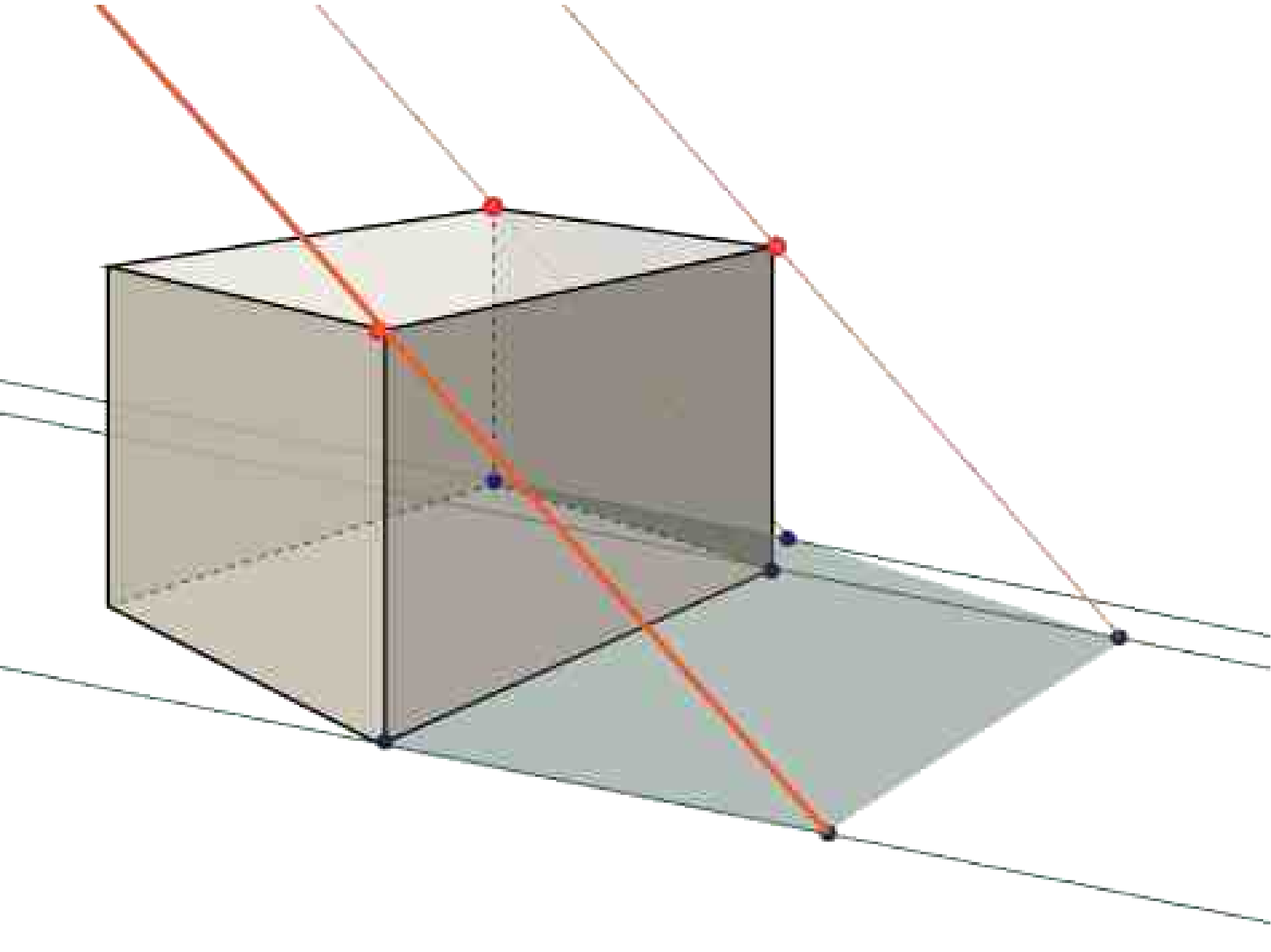

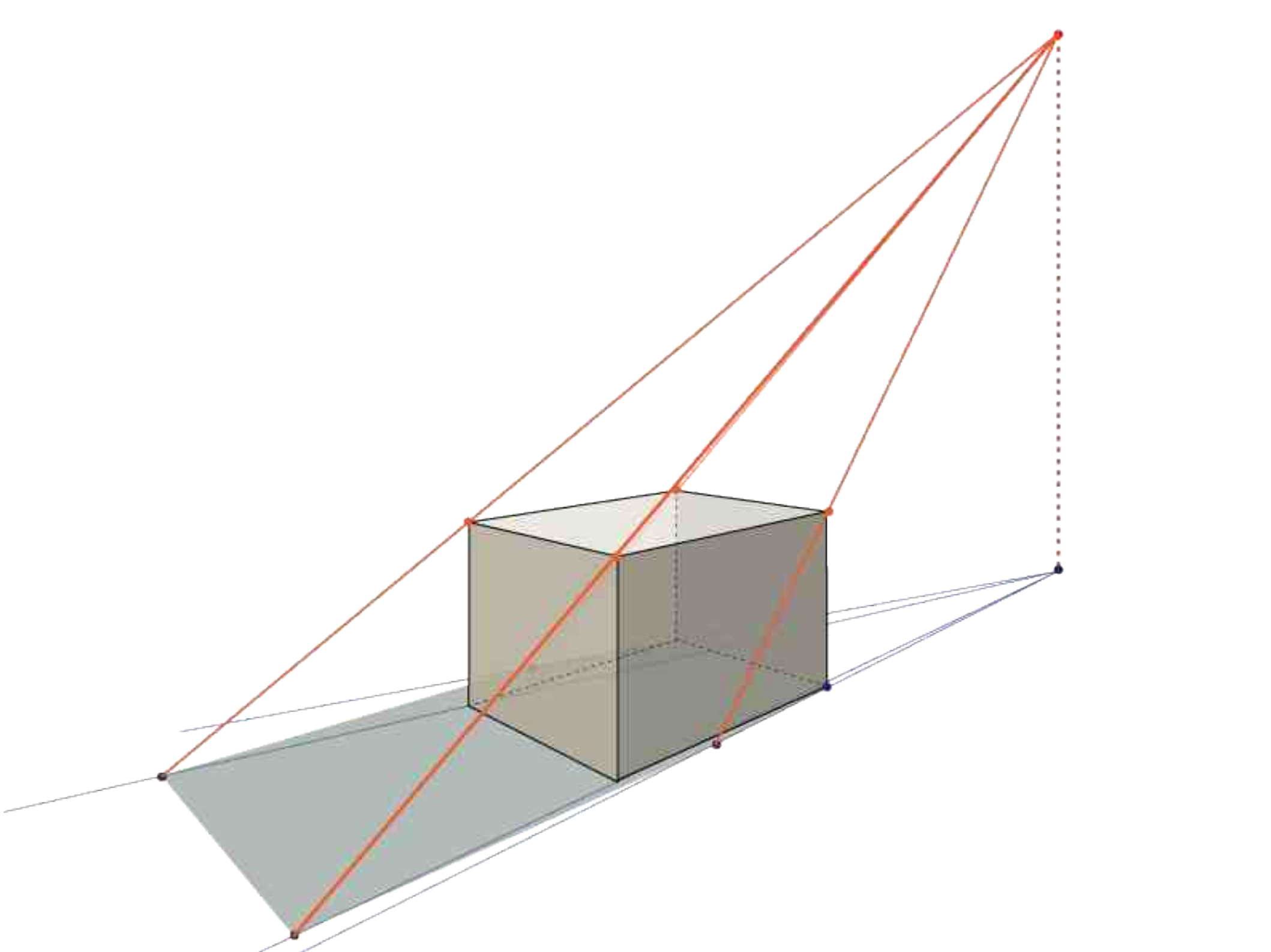

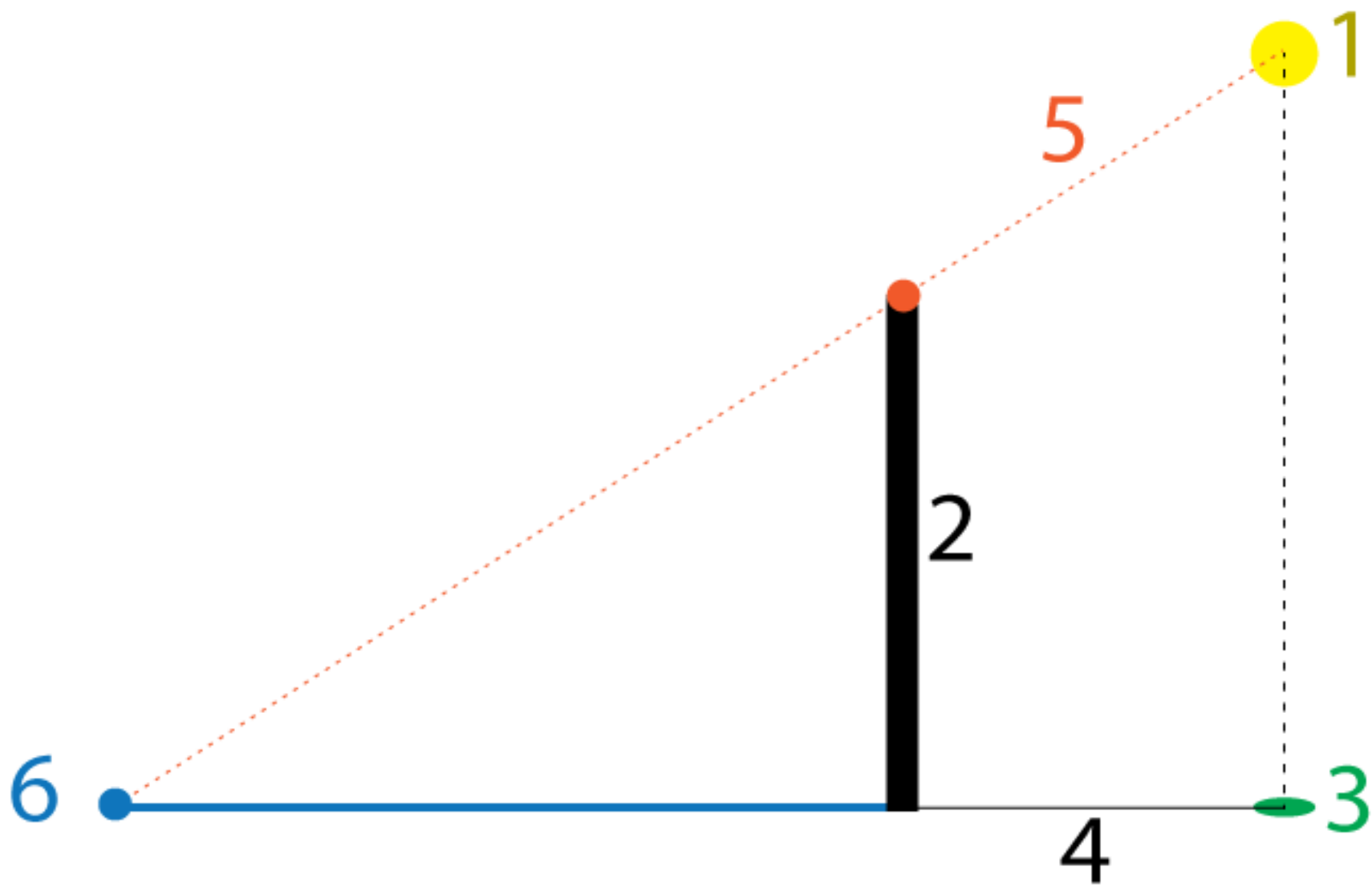

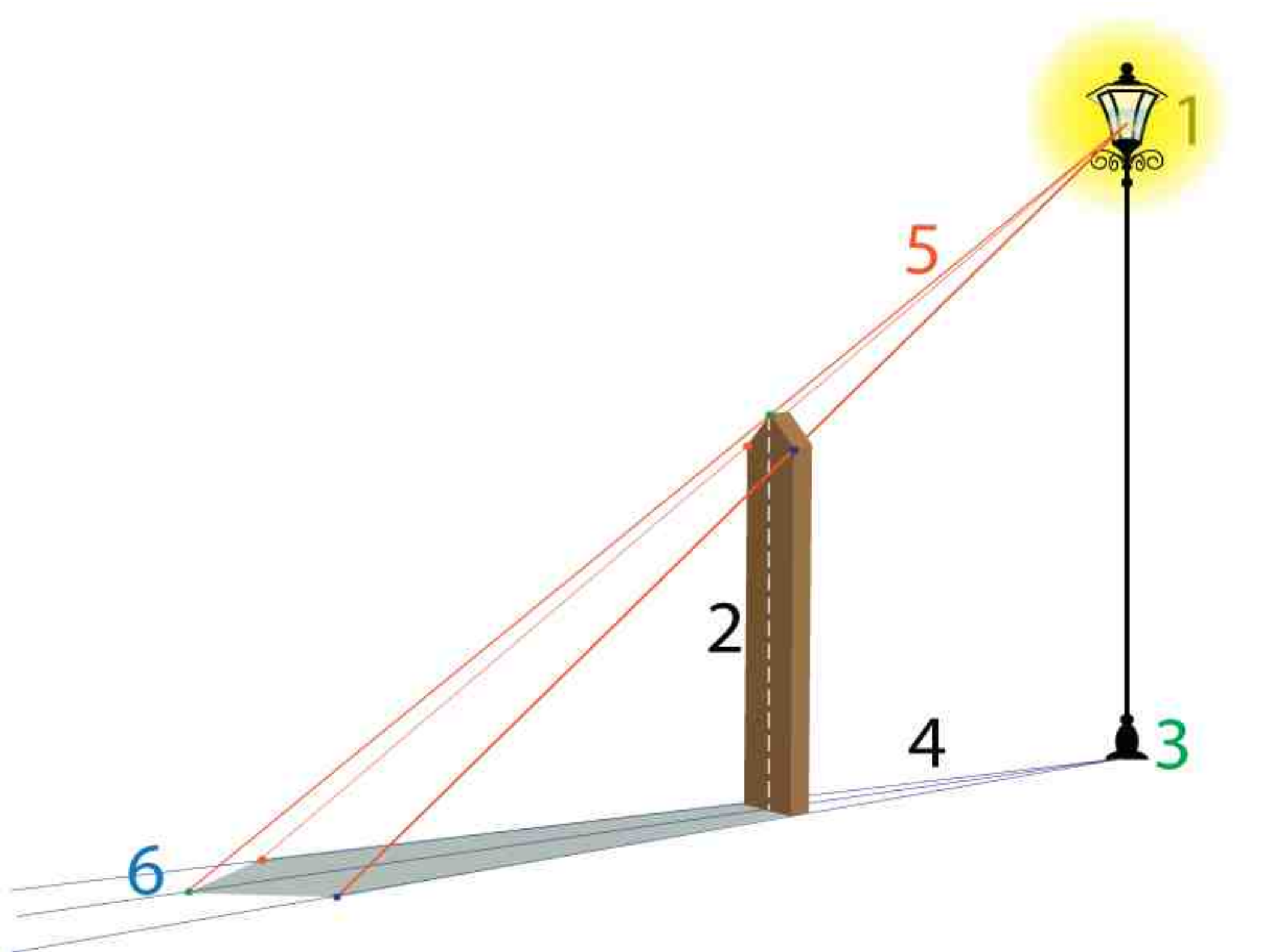

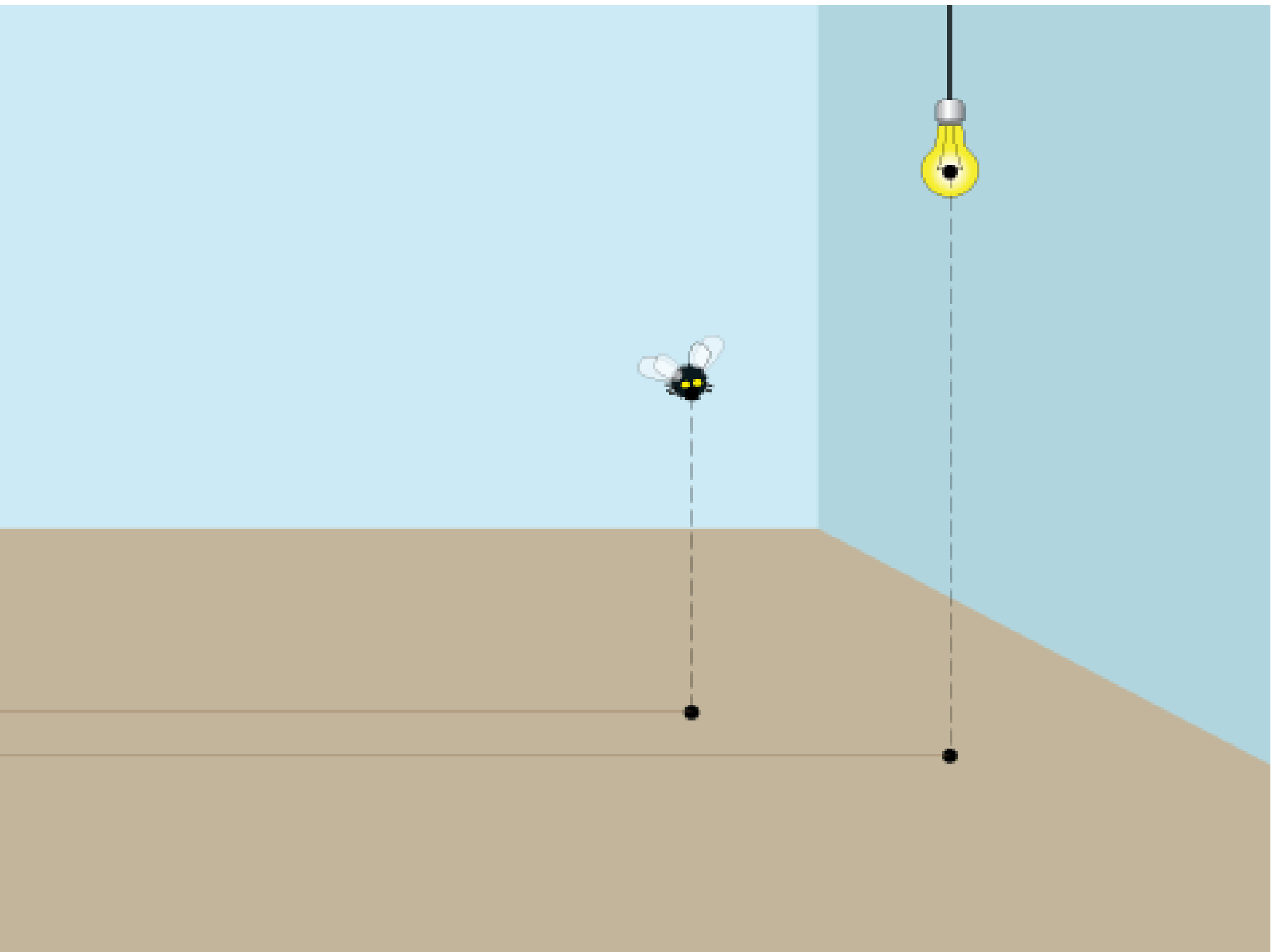

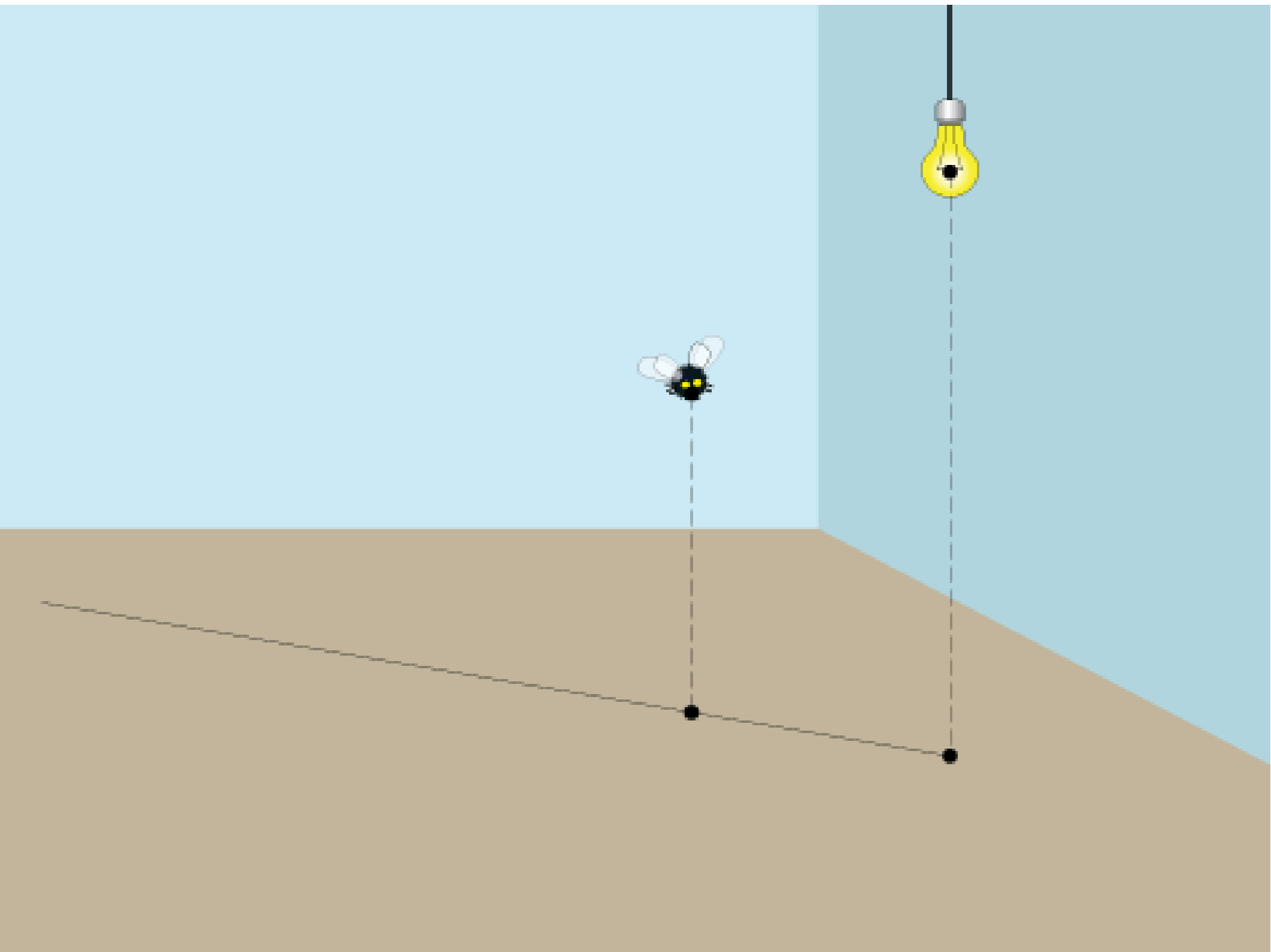

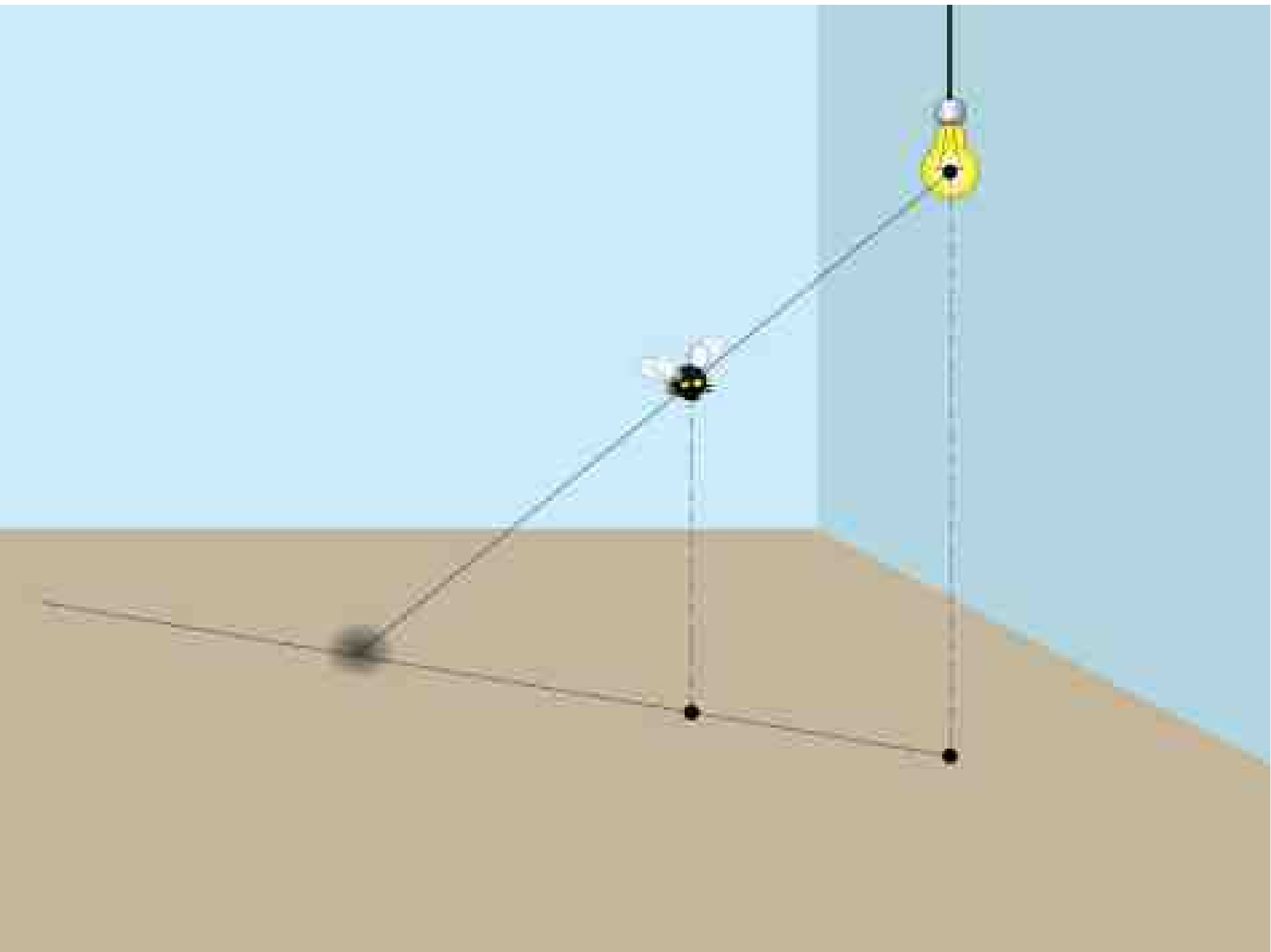

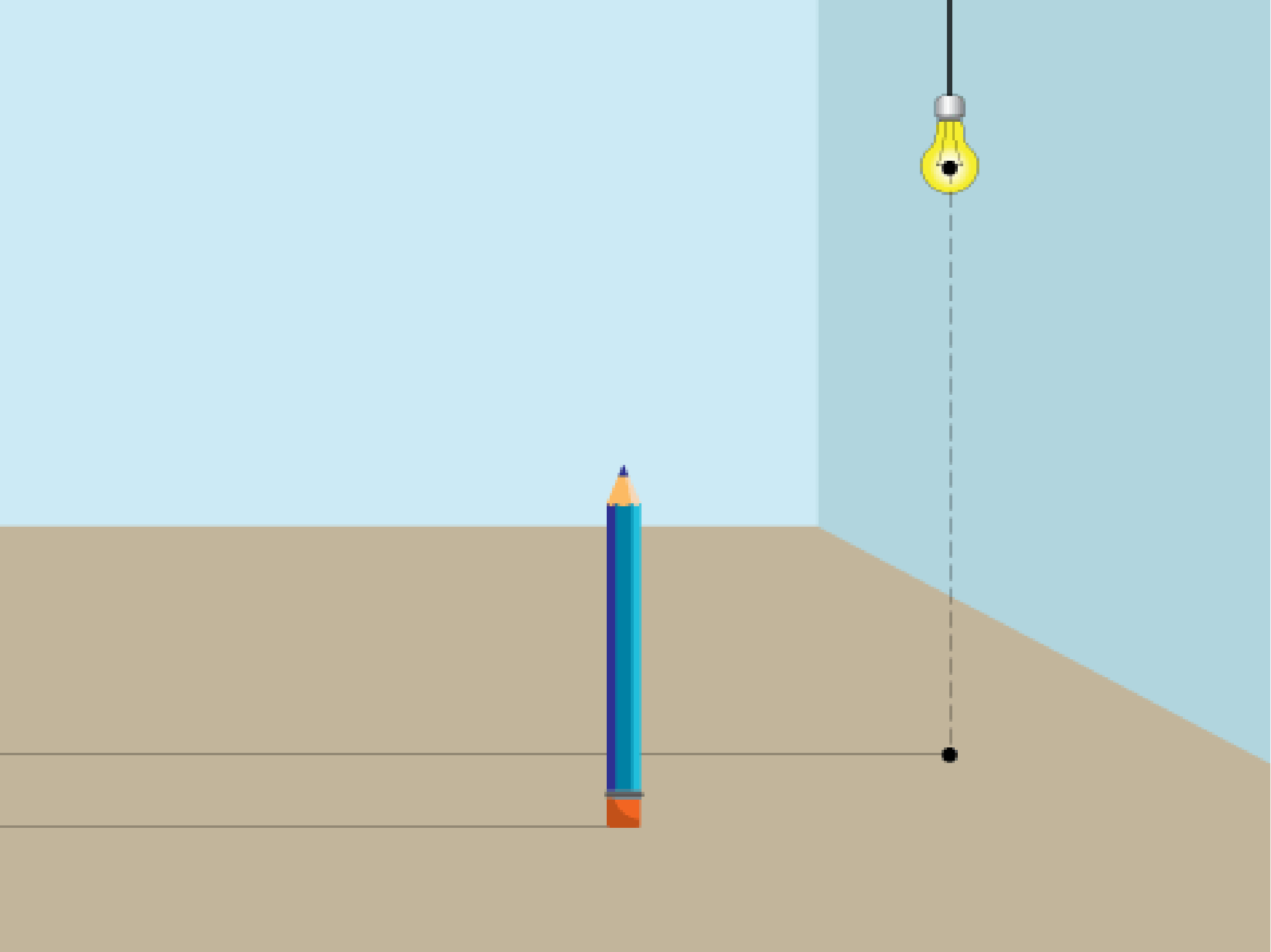

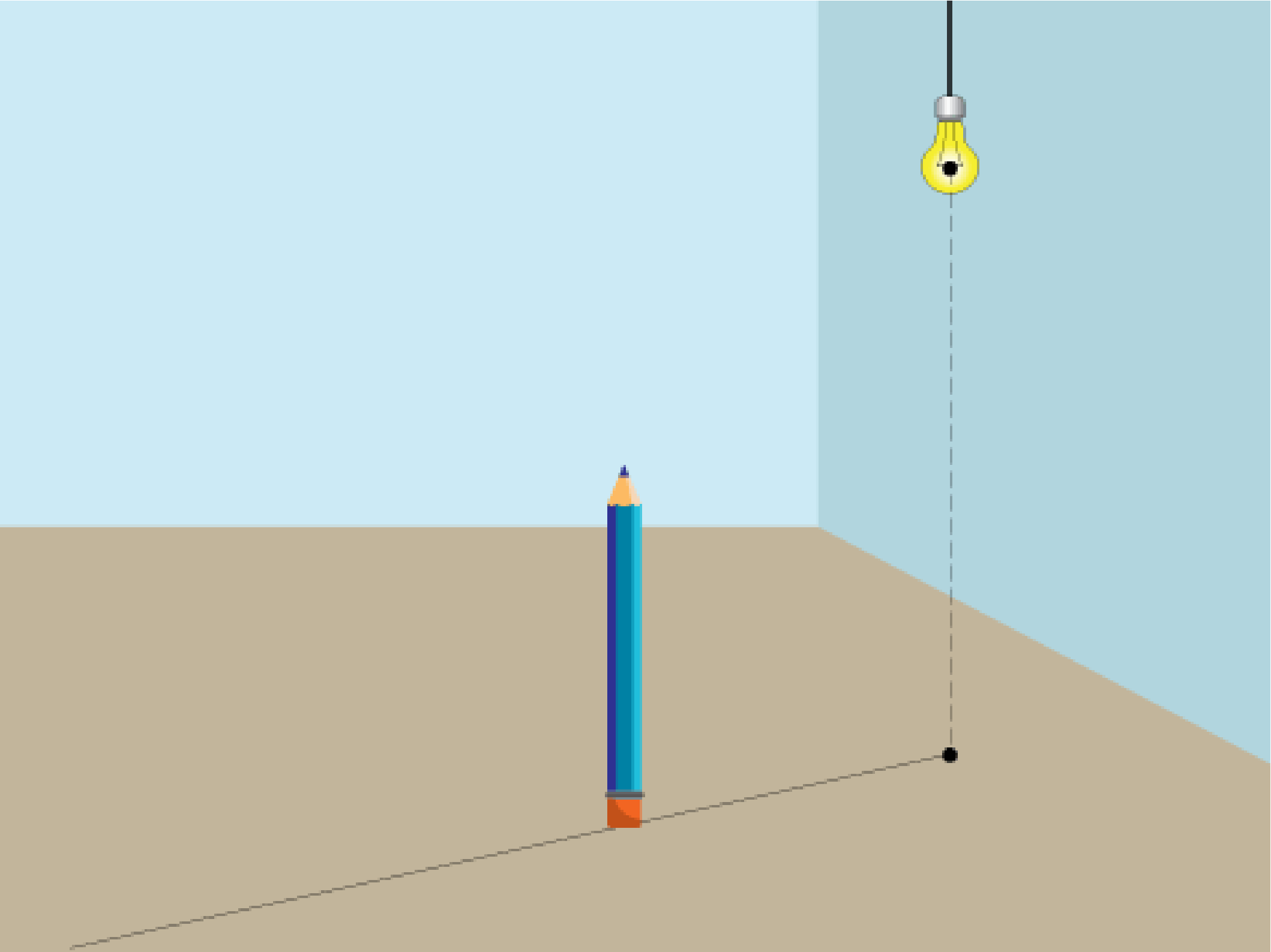

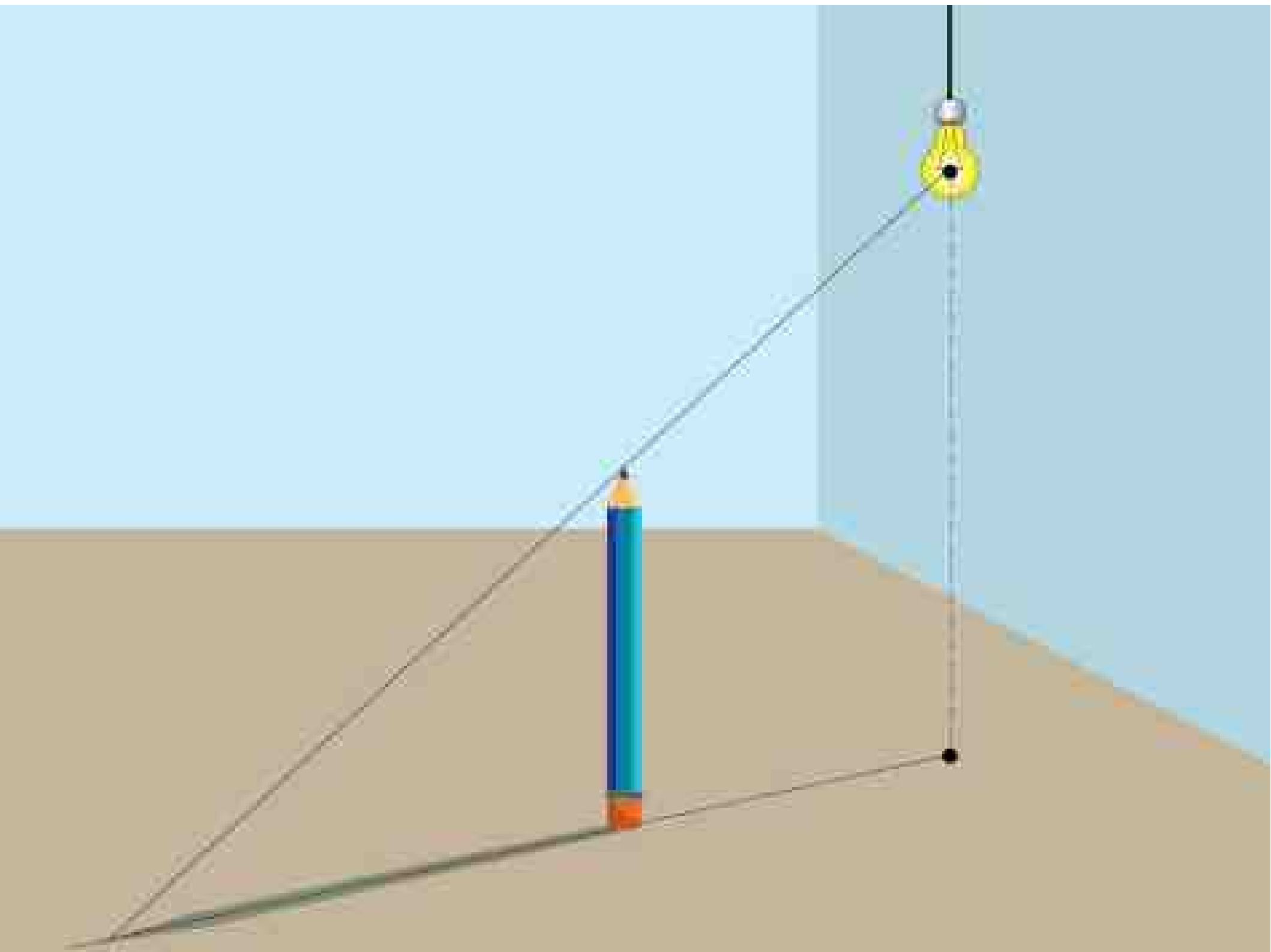





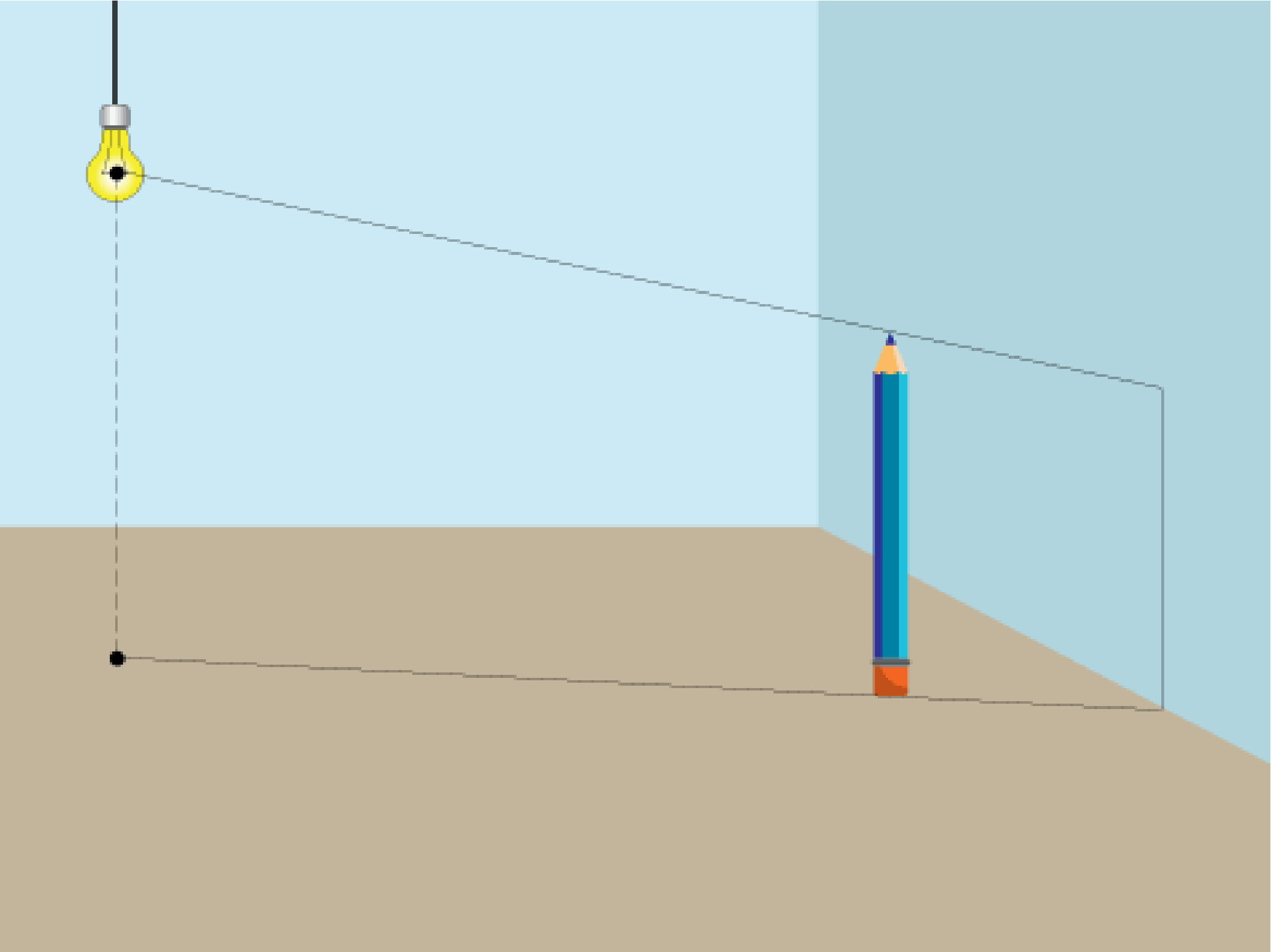

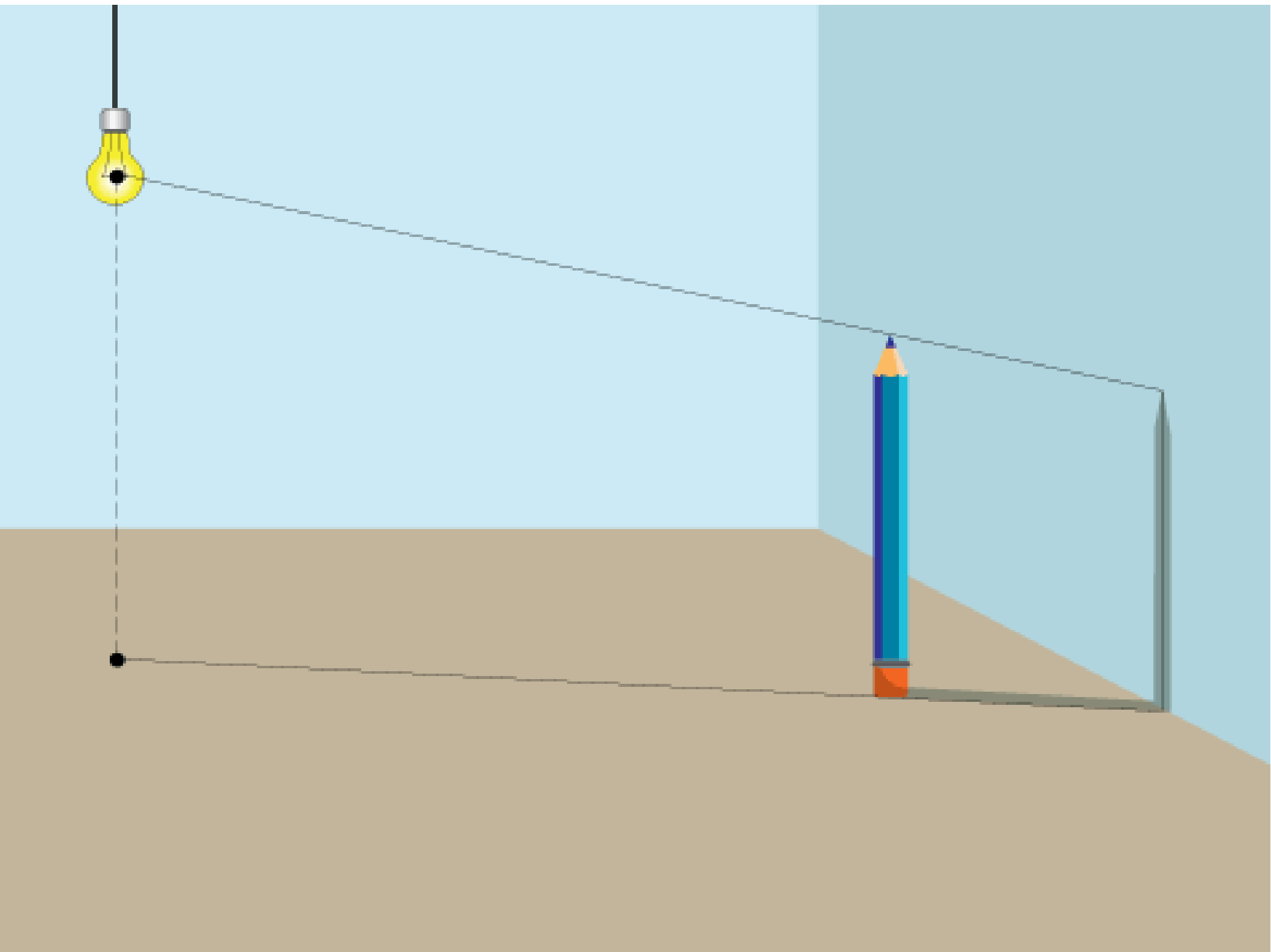

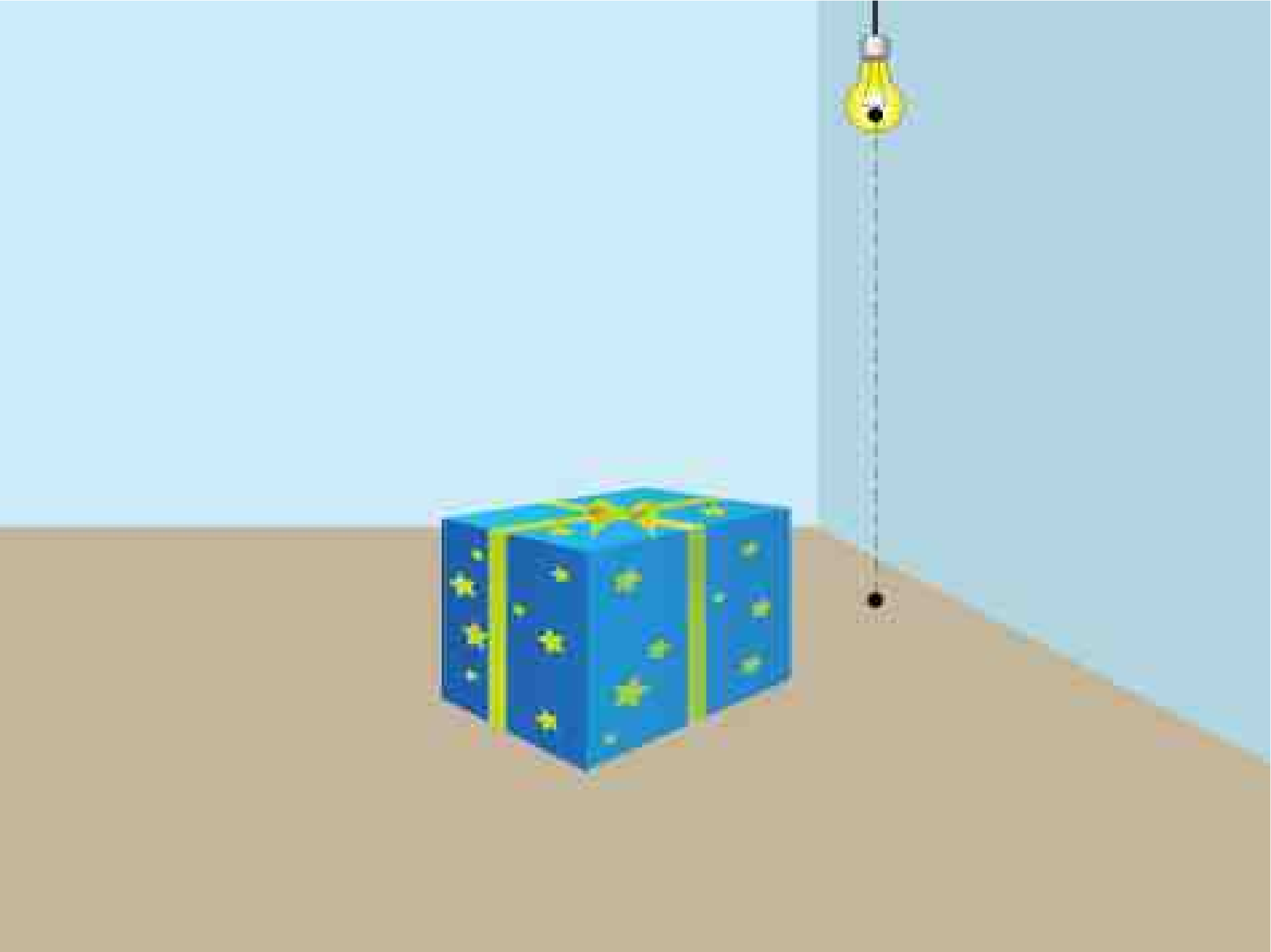

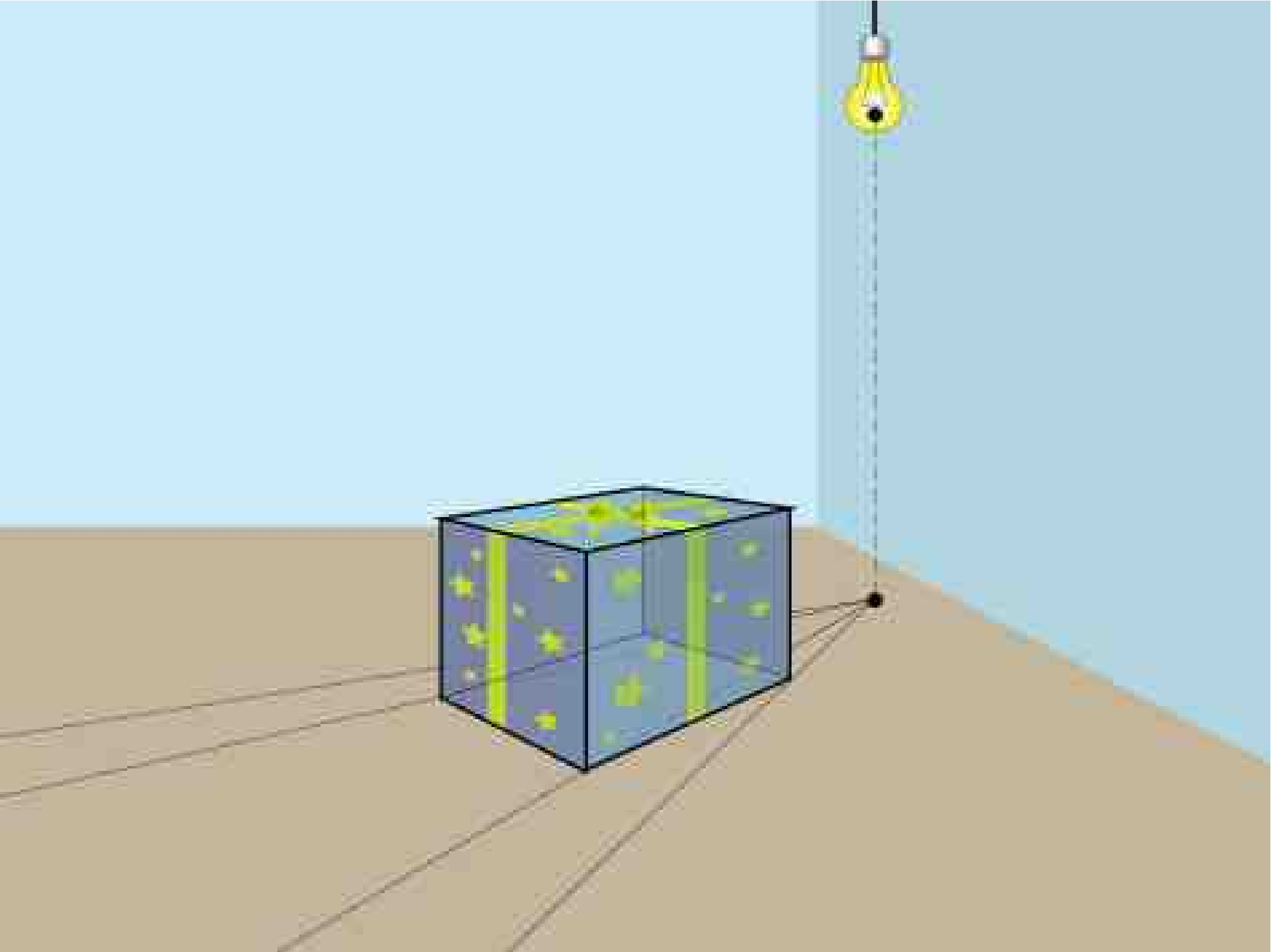

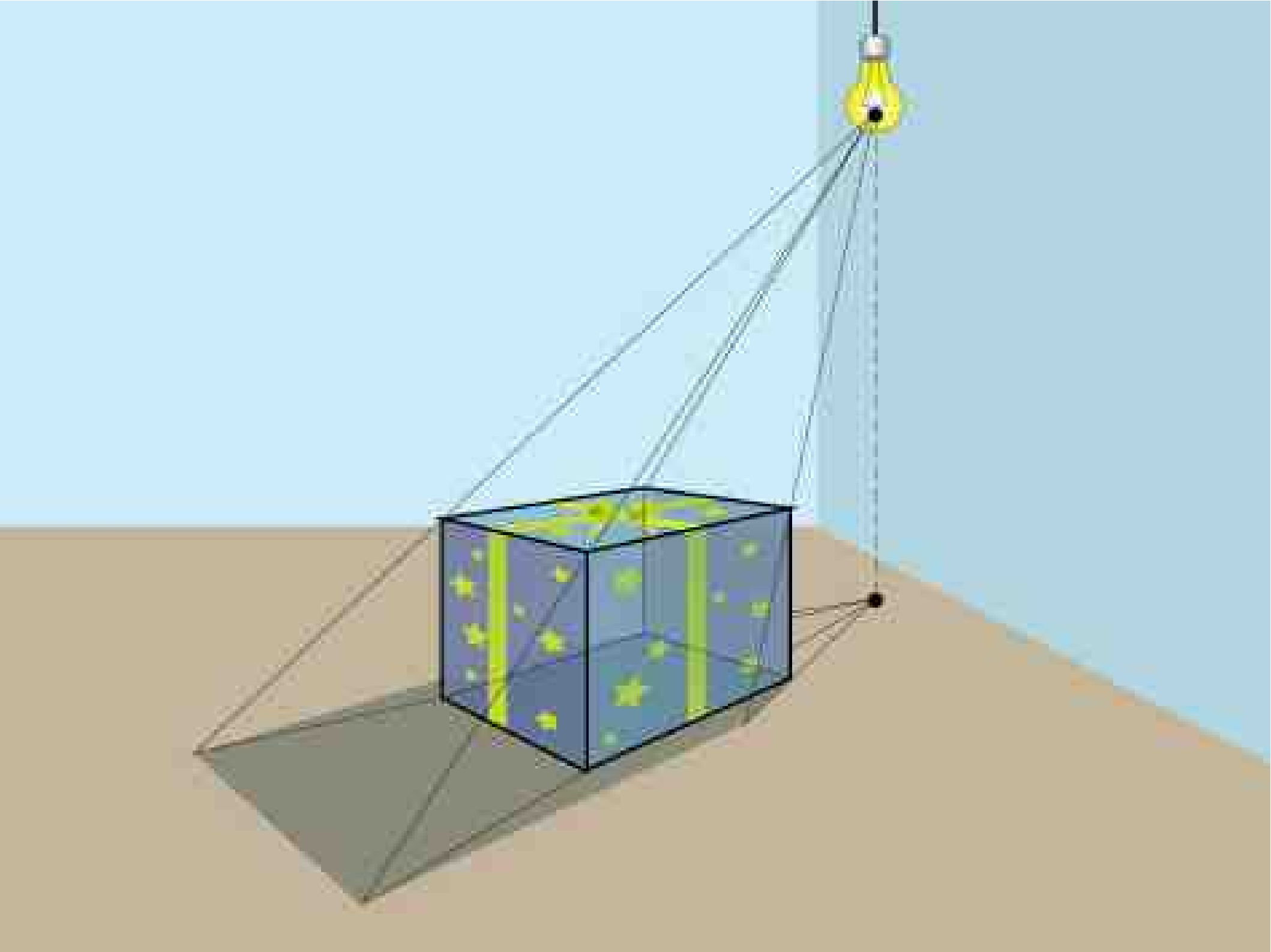



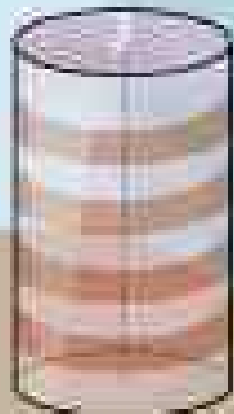
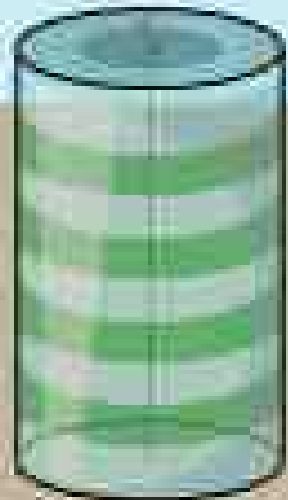

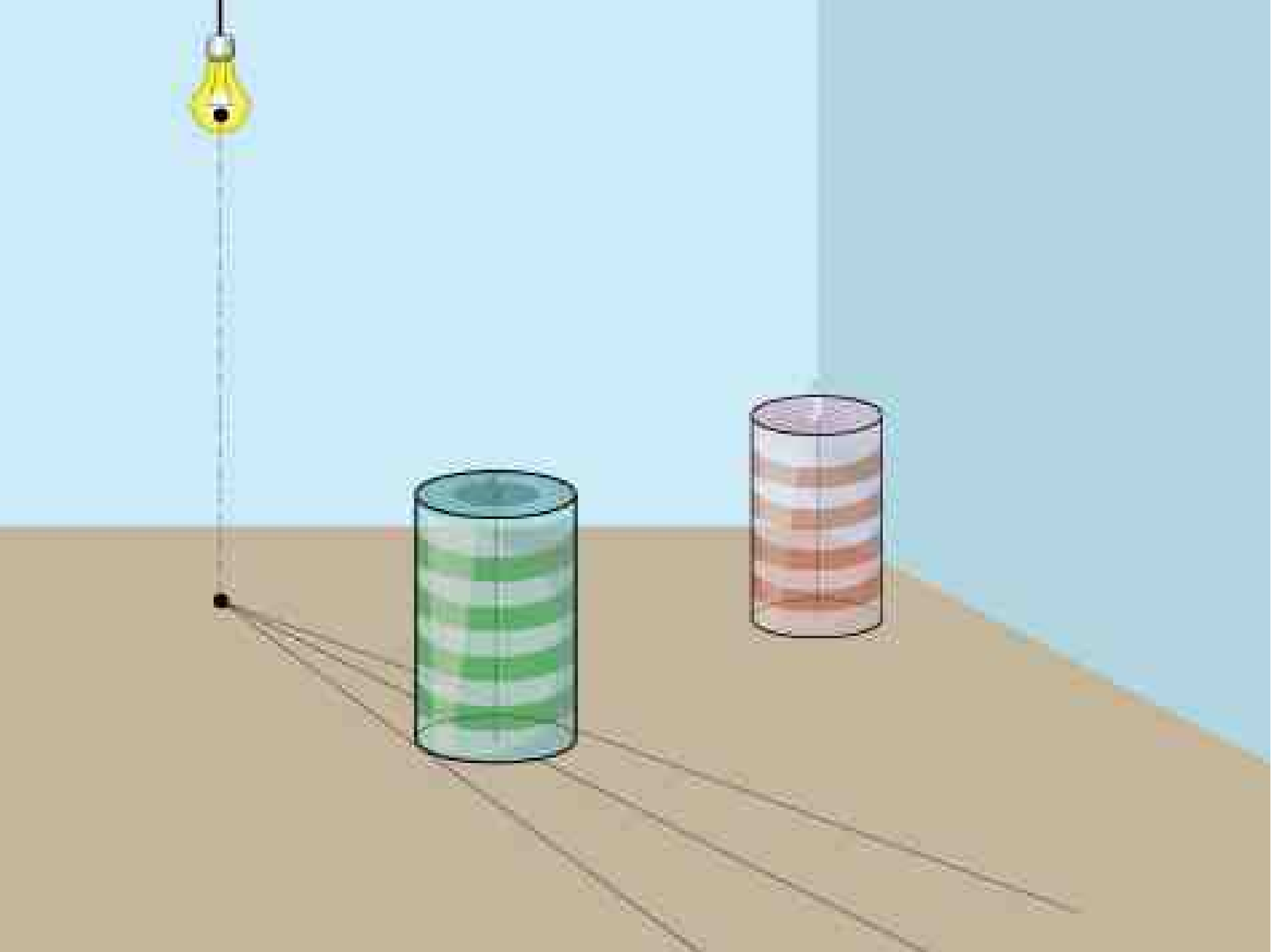

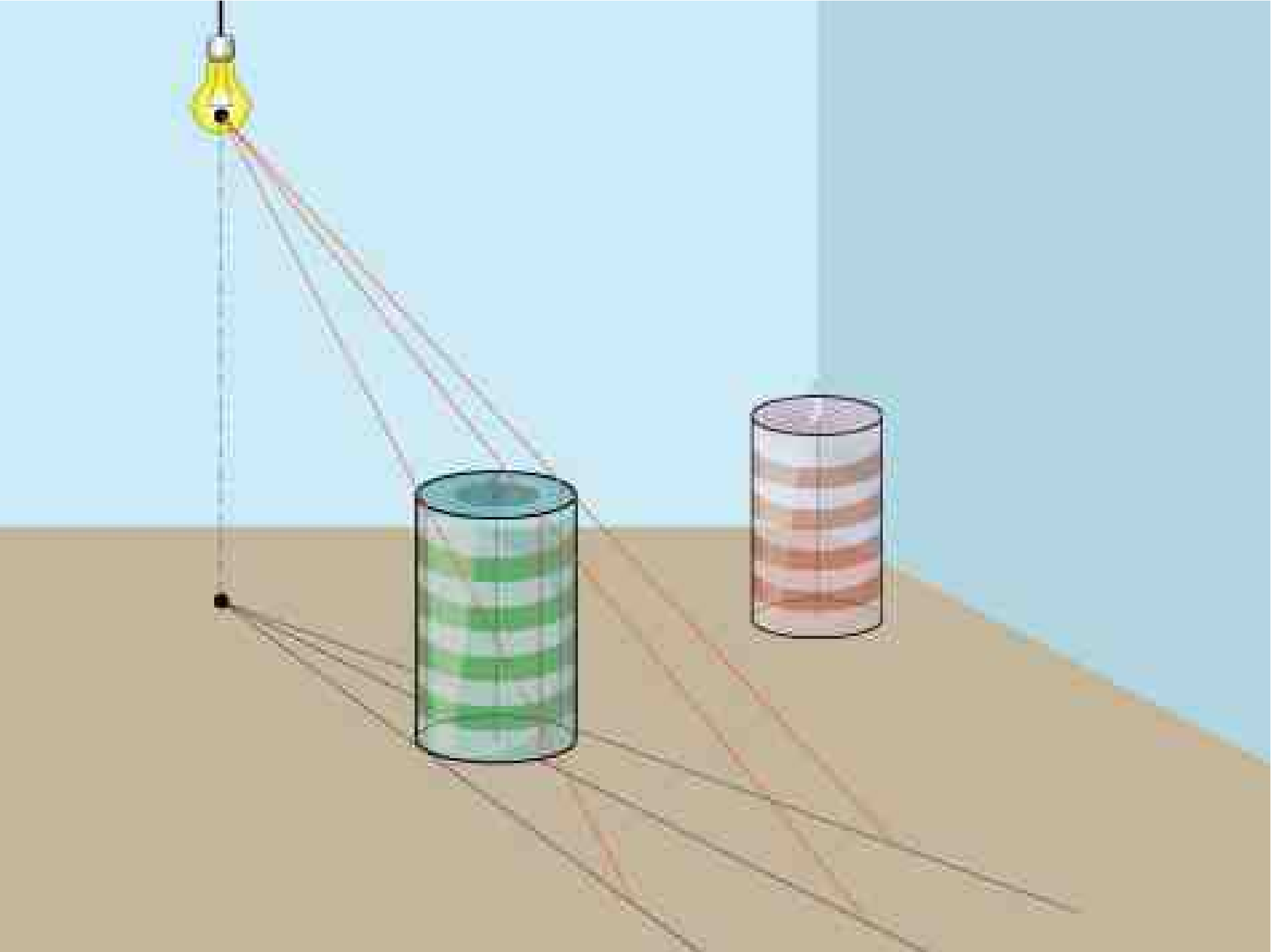

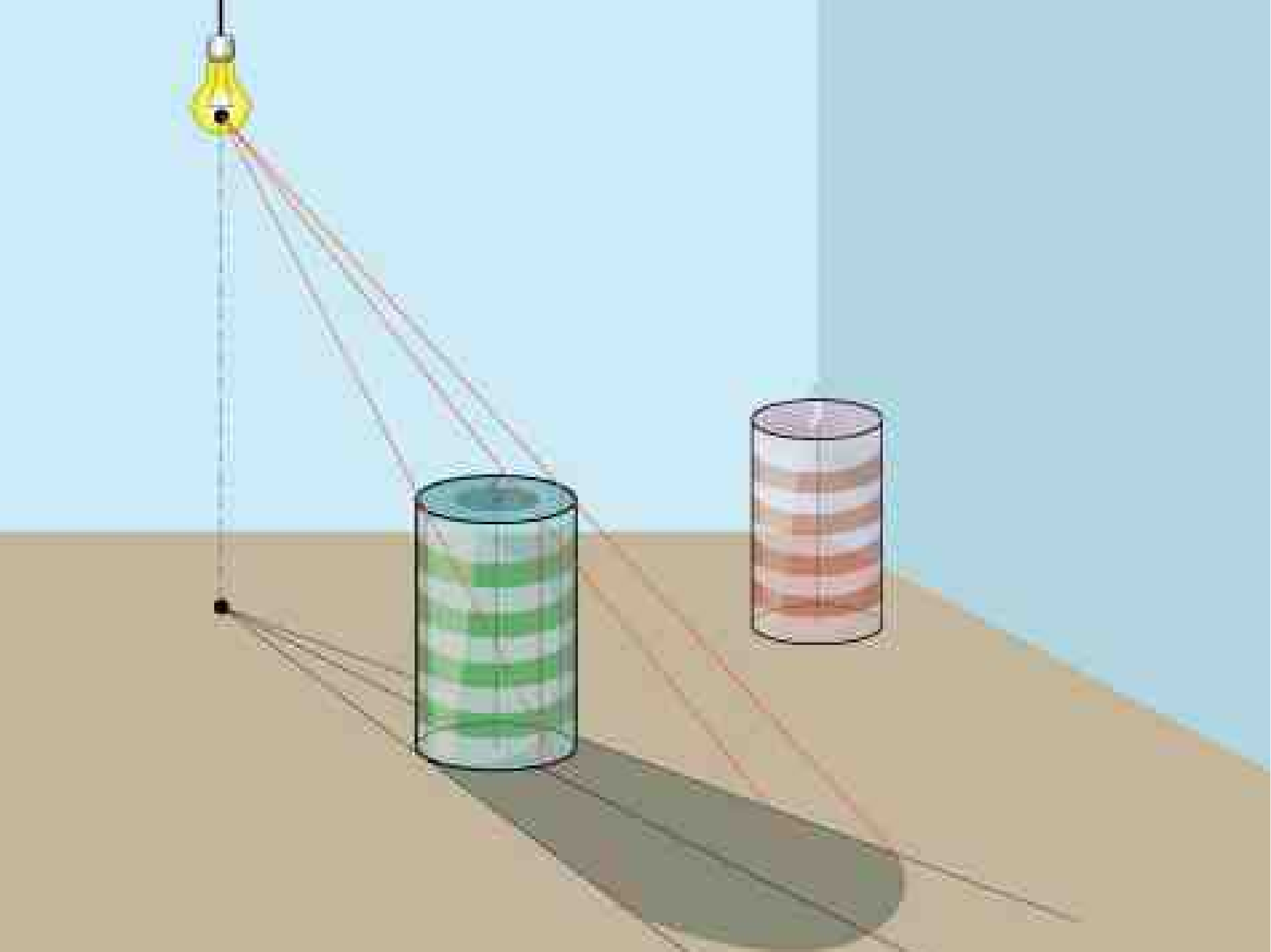

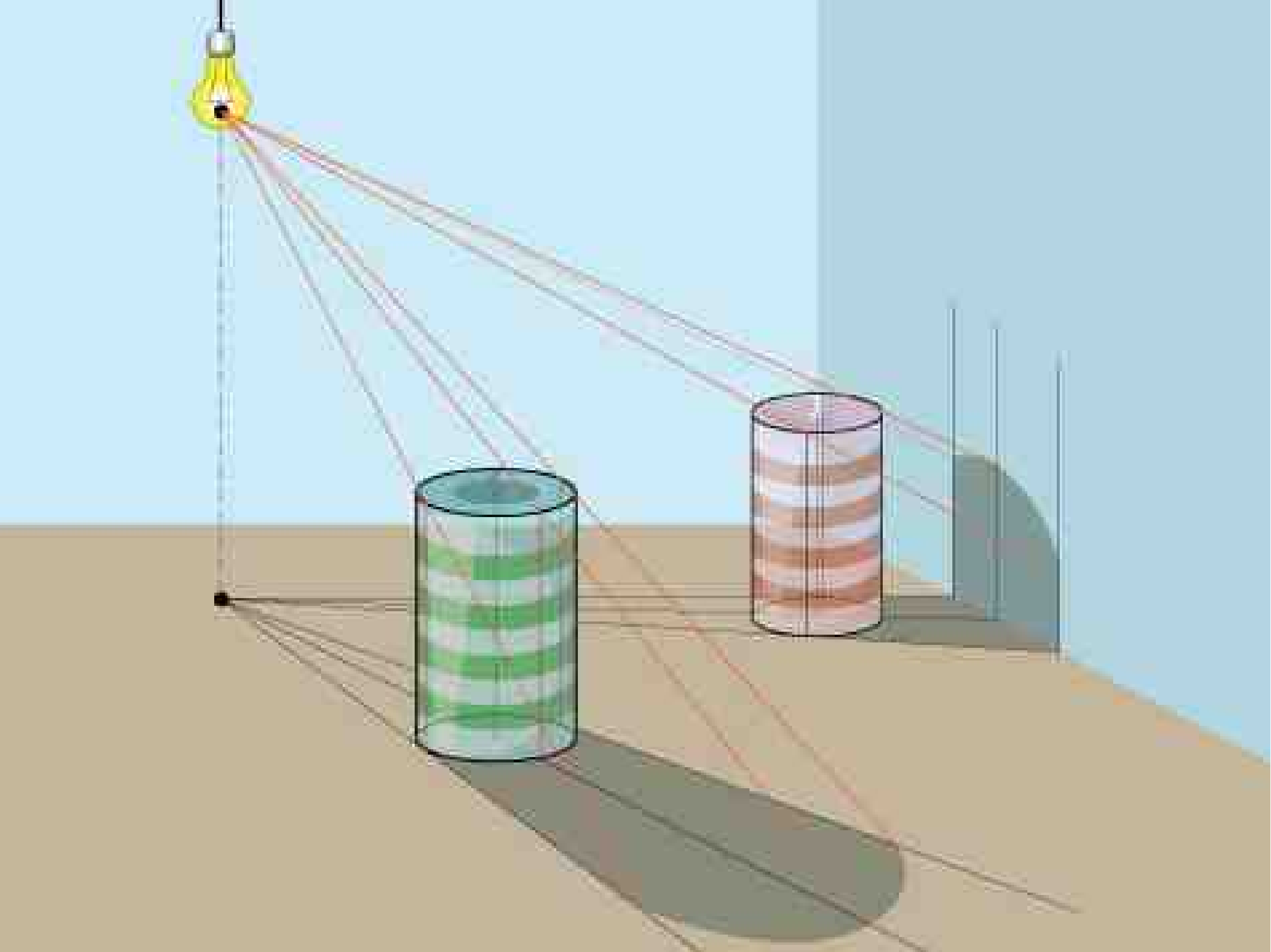

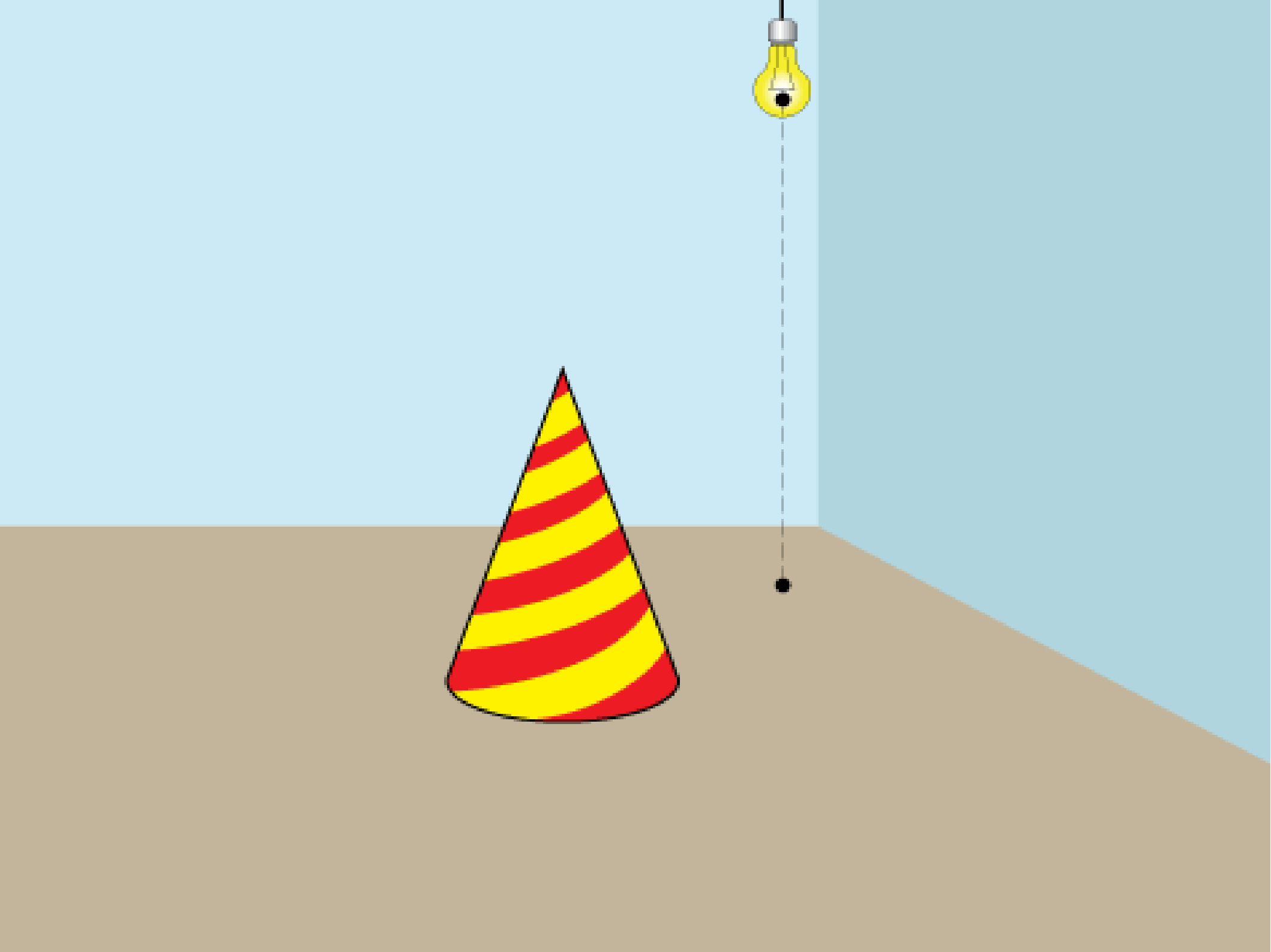

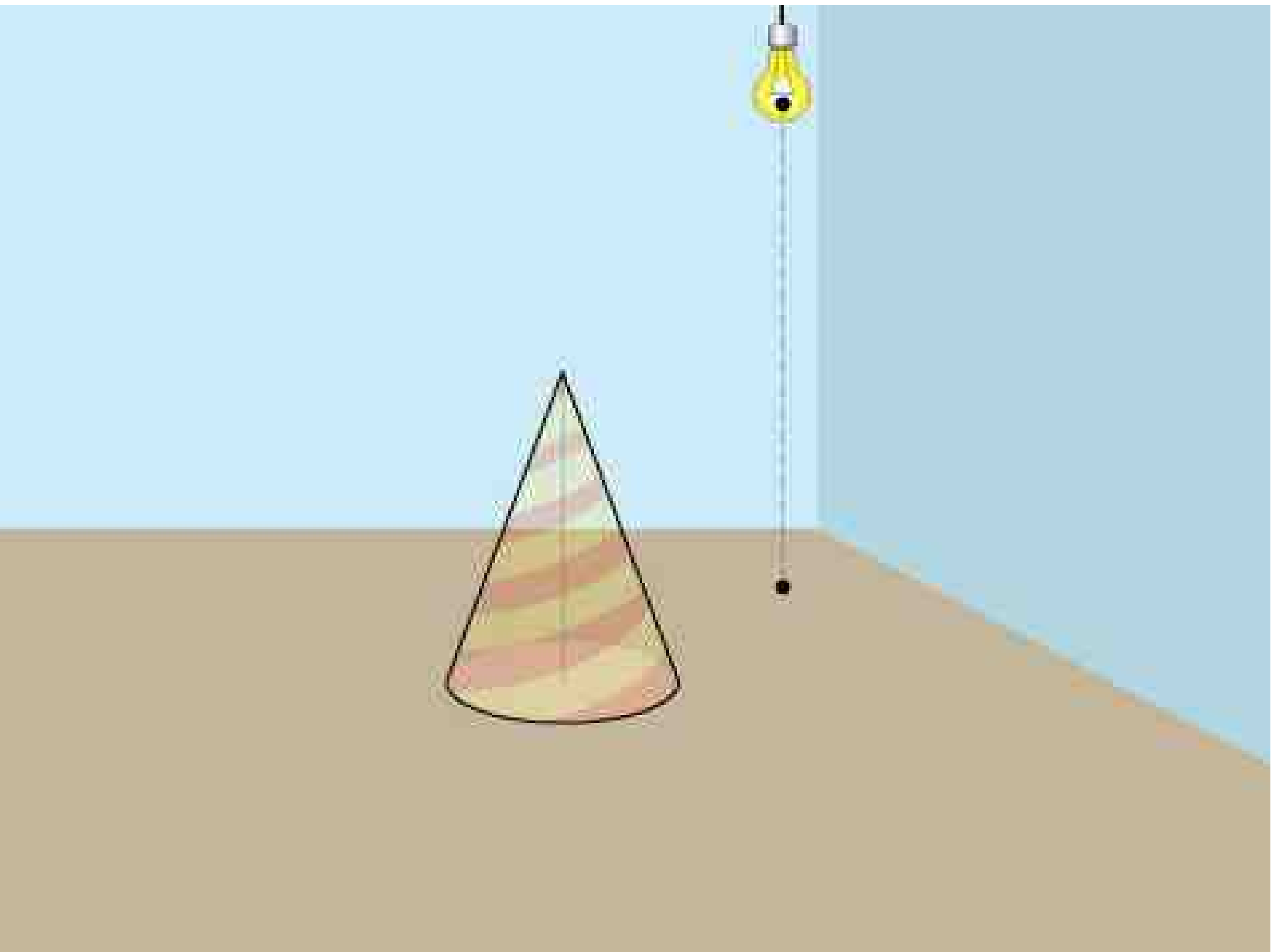

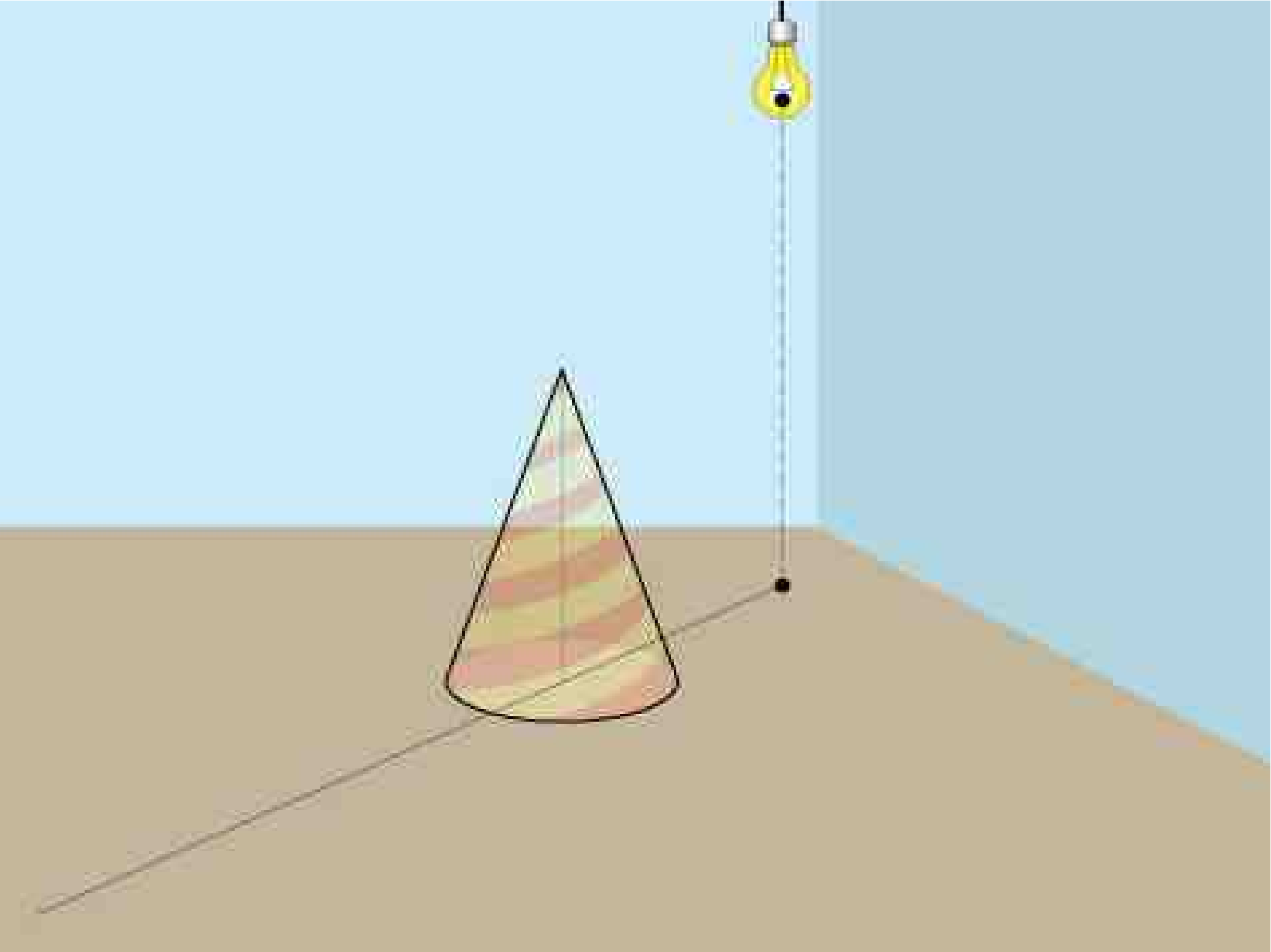

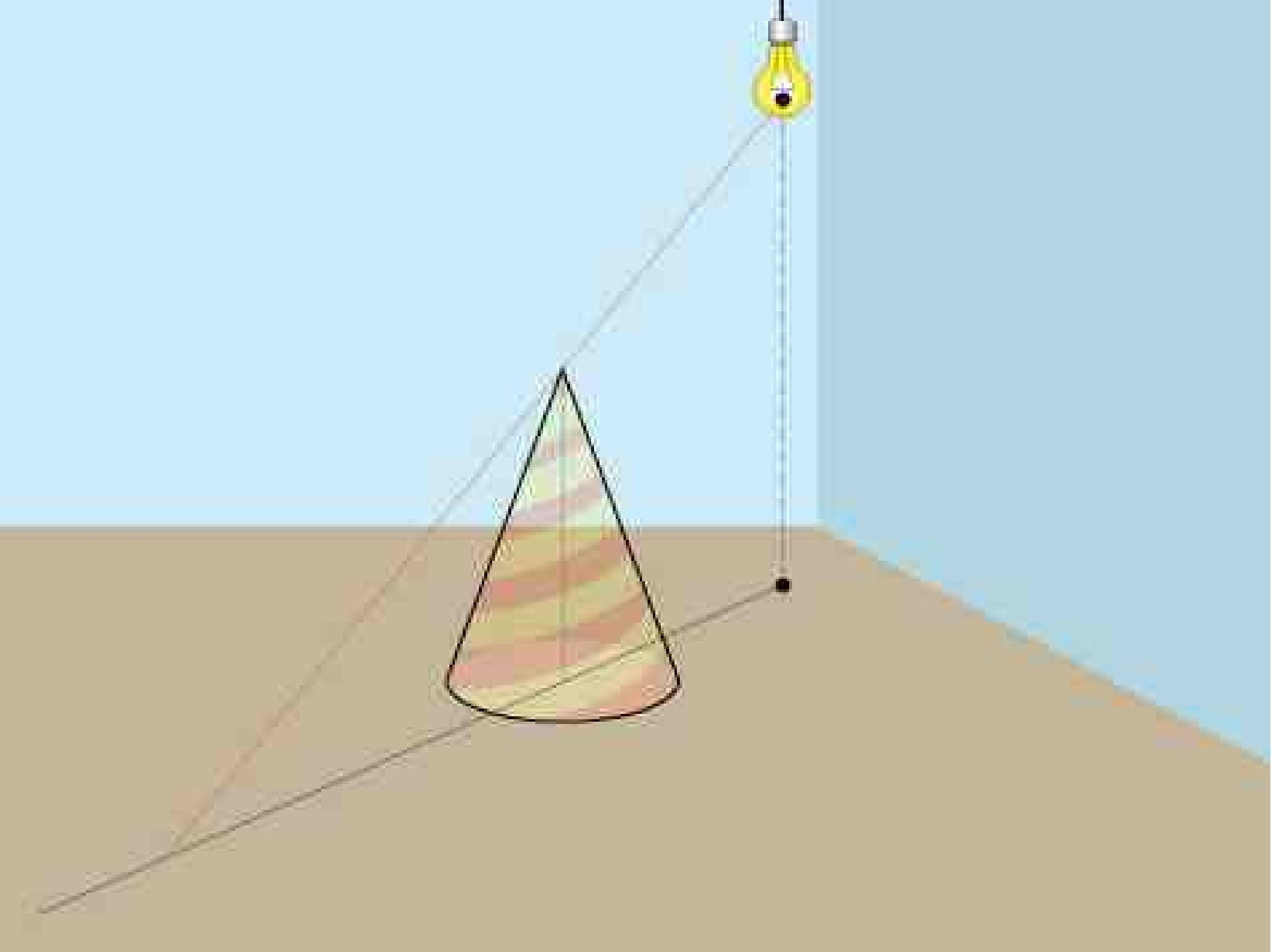

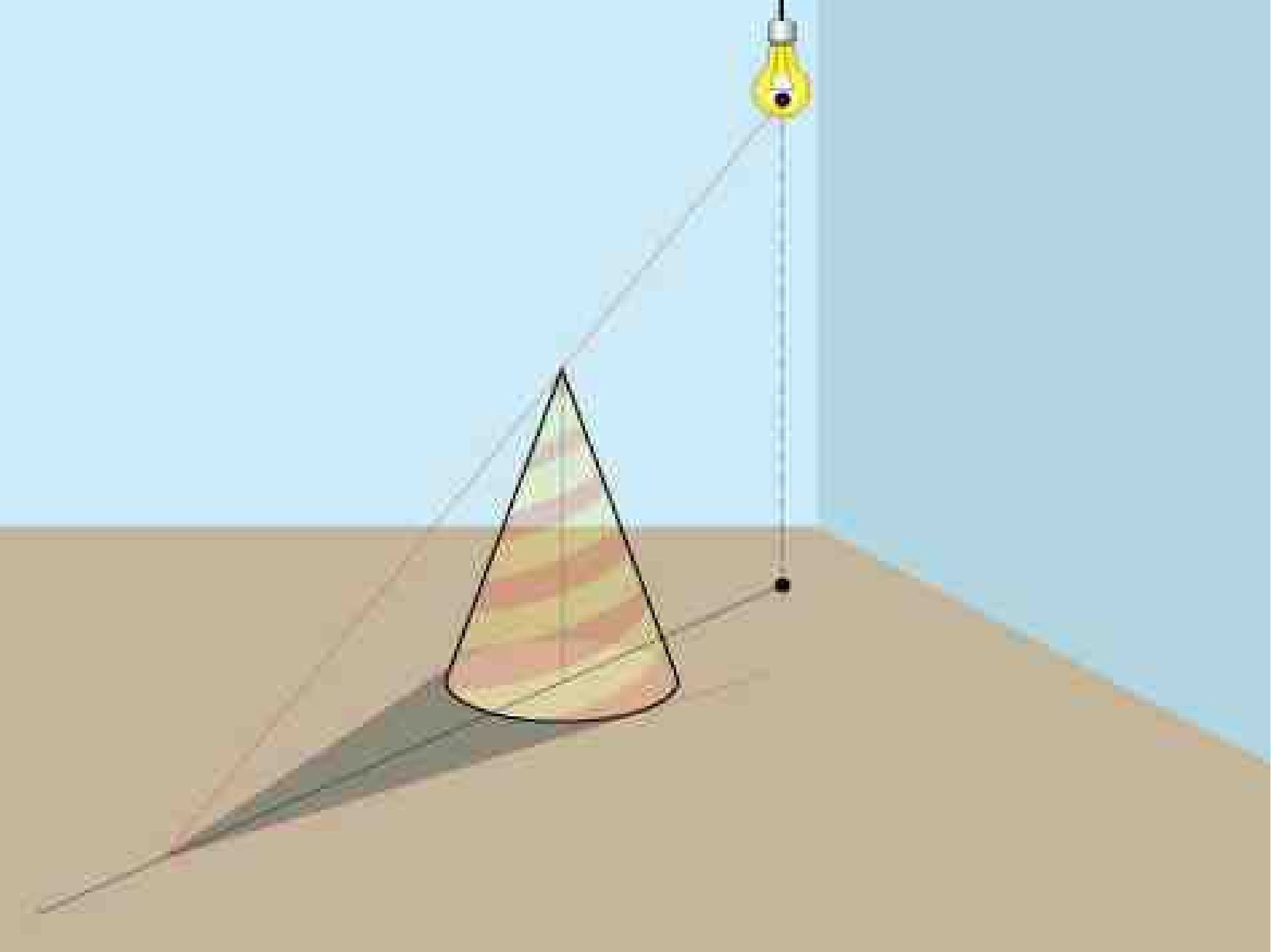

Exercice N°1

Positionner les ombres des 4 mouches dans cette pièce éclairée par une ampoule

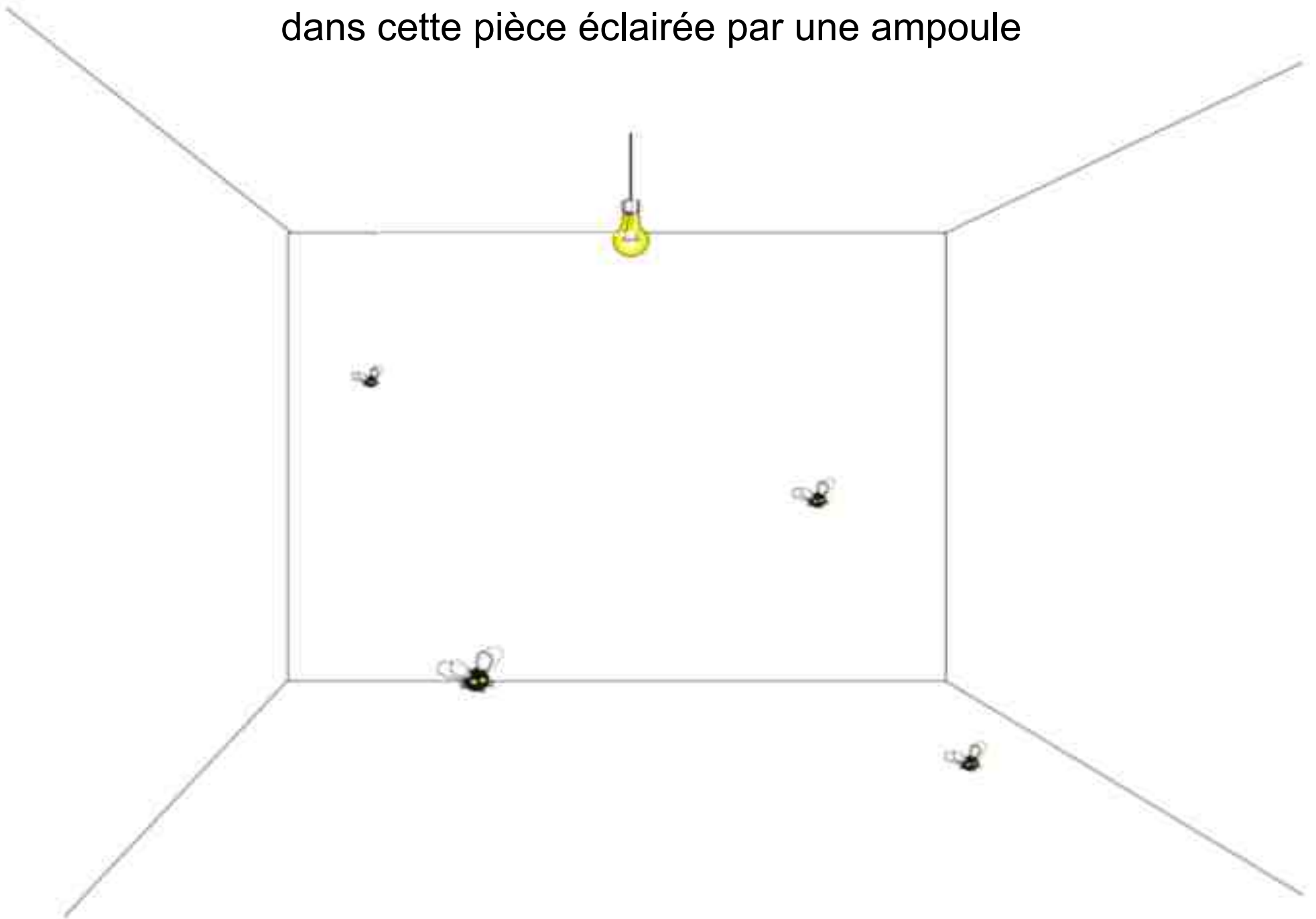

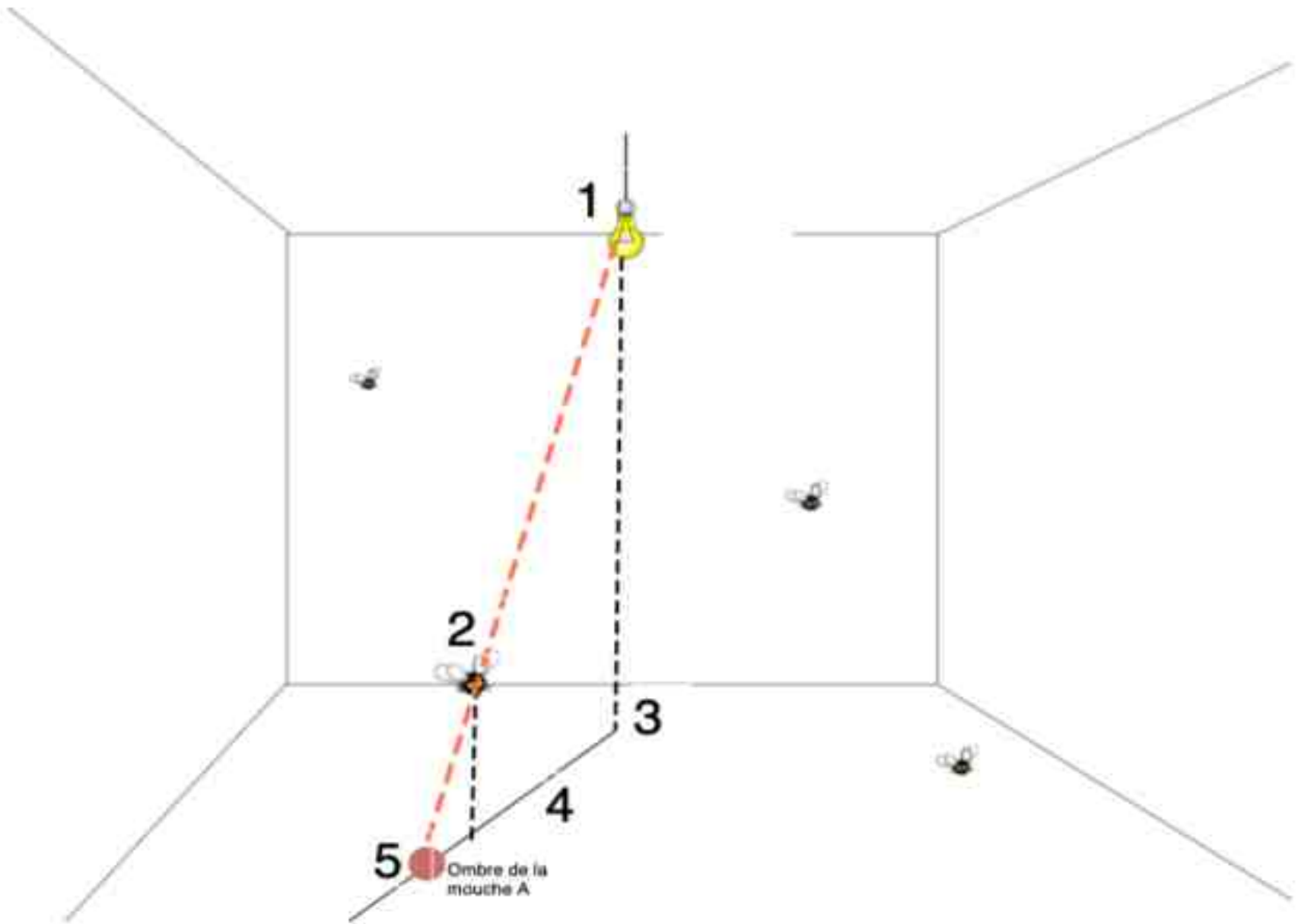

5 Ombre de la vache A

Exercice N°2

Positionner les ombres des poteaux dans cette pièce éclairée par une ampoule

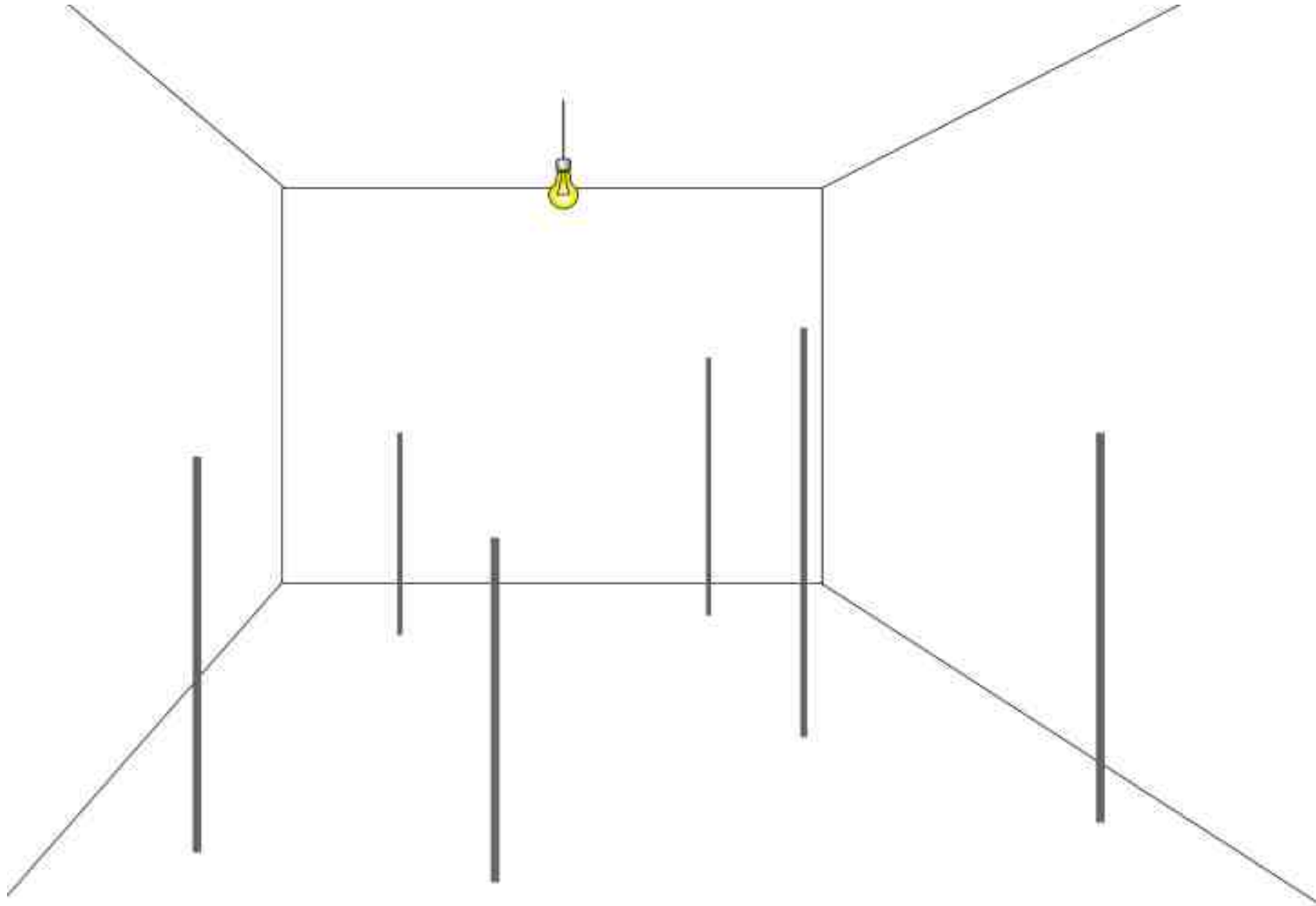

Exercice N°2
Positionner les ombres des poteaux
dans cette pièce éclairée par une ampoule

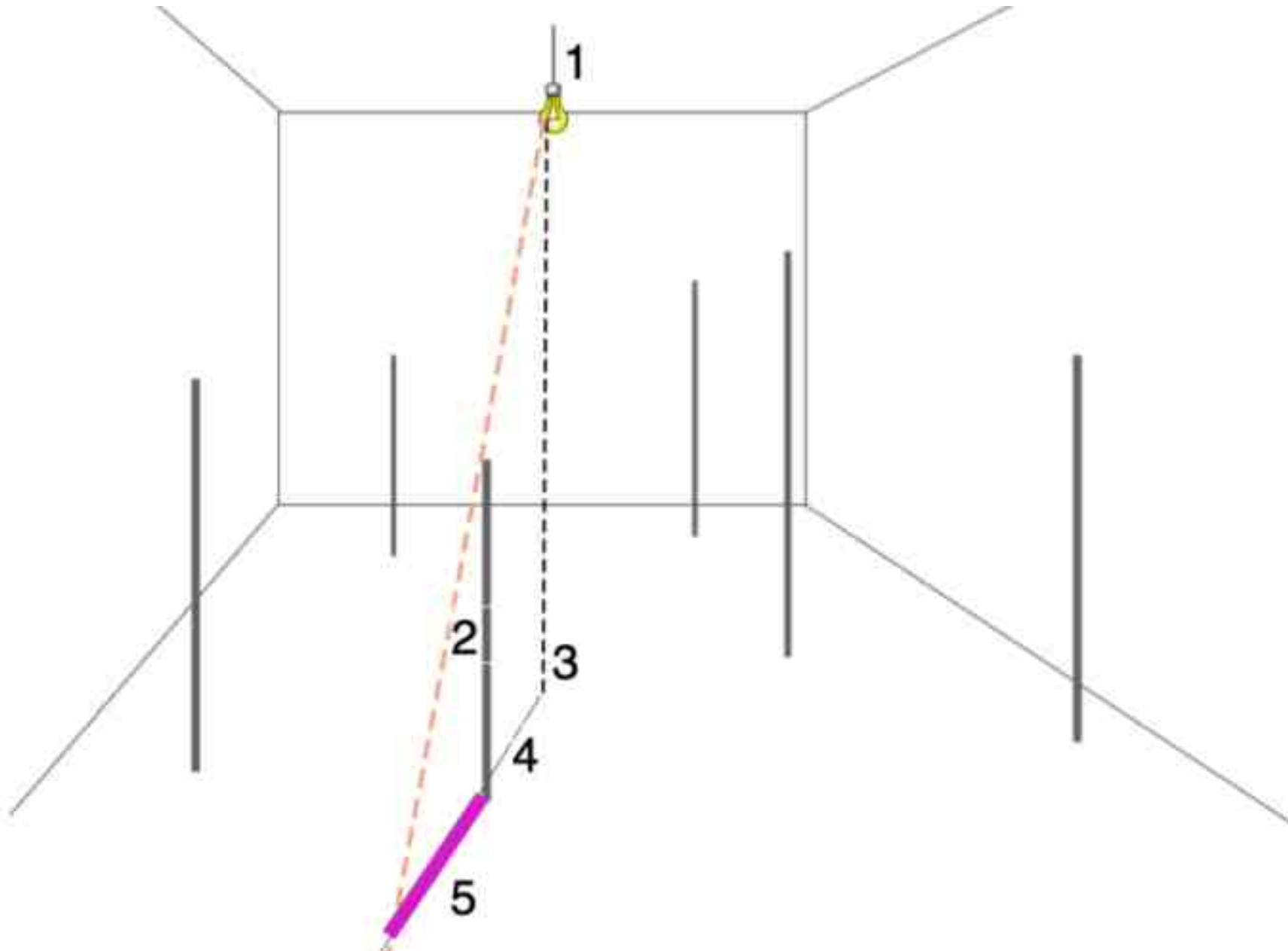

Exercice N°3
Positionner les ombres des cubes
posés à terre et éclairée par un réverbère

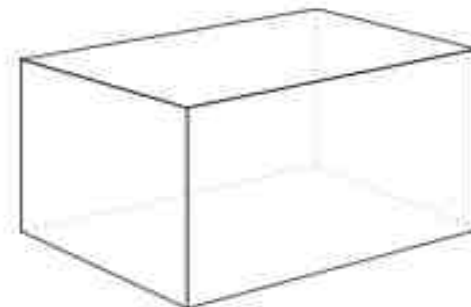
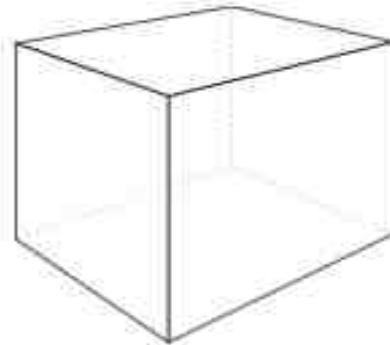
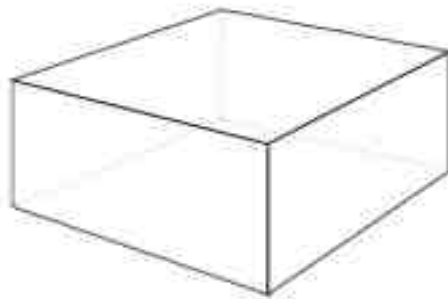

Exercice N°3
Positionner les ombres des cubes
posés à terre et éclairée par un réverbère

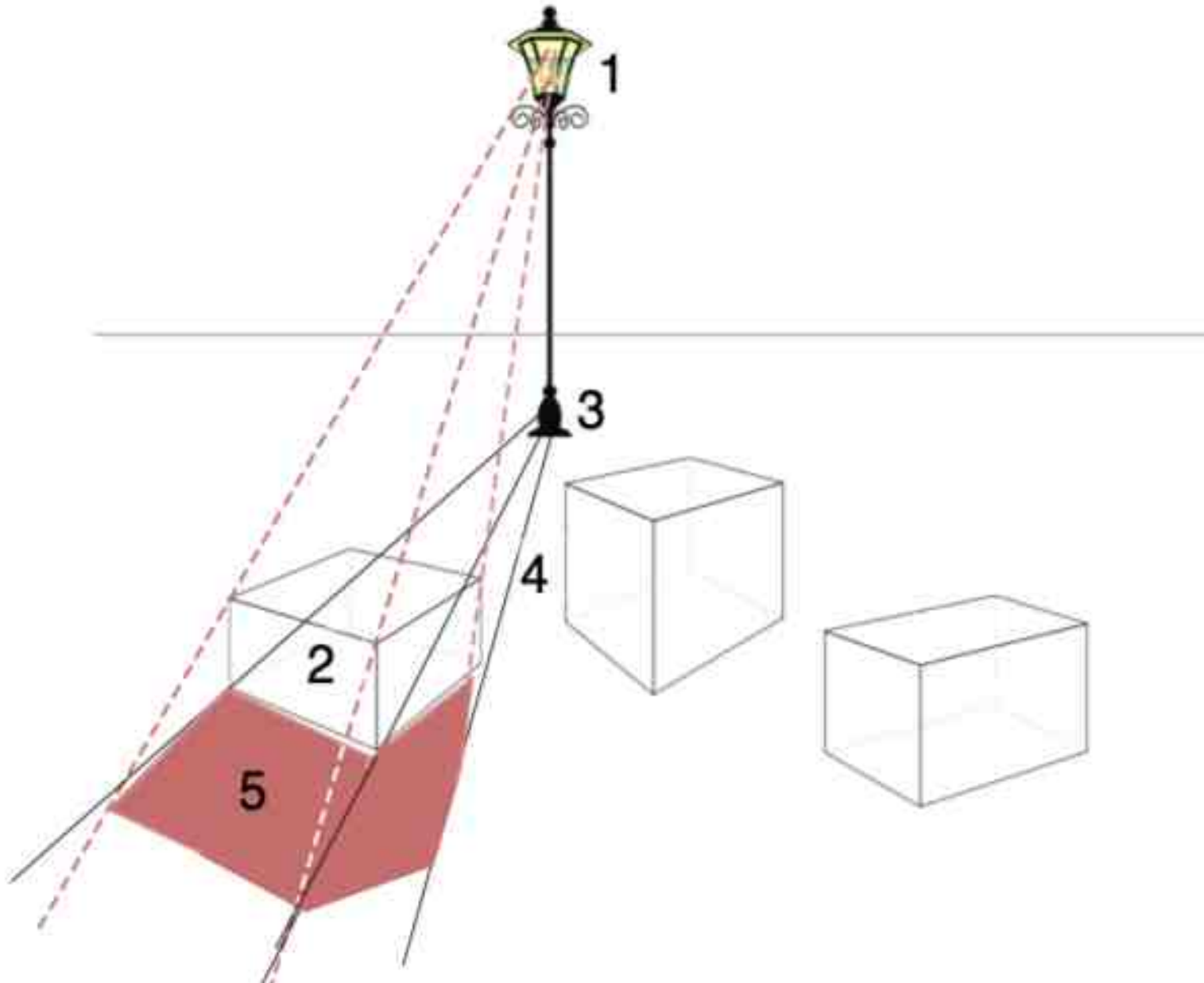

Exercice N°4

Positionner les ombres des cylindres et du cône posés à terre et éclairée par un réverbère

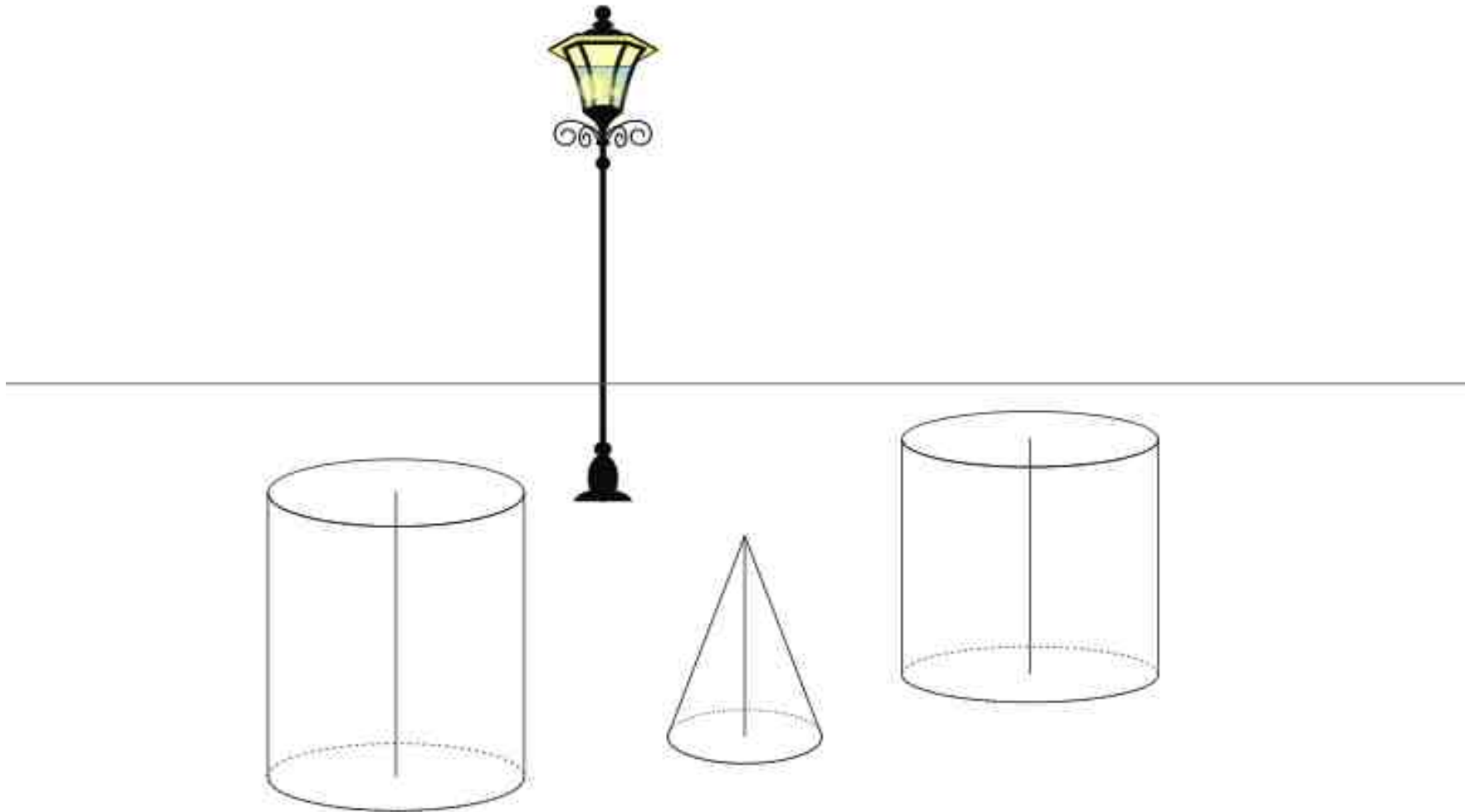

Exercice N°4

Positionner les ombres des poteaux

